



Island Stone[®]



WELCOME TO ISLAND STONE

CREATING A WORLD OF DIFFERENCE.

2018 marks twenty years since our company began sourcing, processing, and designing stone products that have enhanced homes, commercial projects, luxury retailers and hotels across the world.

Our steadfast team continues to create products that convey both the timelessness of tradition and the modern, chic, and functional aesthetic suited to today's consumer.

This dedication to innovation has allowed our range of tiles and claddings to encompass exceptional glass and wood offerings. We honor the natural world that gives us inspiration and beautiful materials by reusing, recycling, and taking care of these finite resources.

With offices and factories around the globe, every facet of our organization has to operate flawlessly. By constantly evolving our design systems, manufacturing processes, and supply chain management, we work tirelessly to achieve that goal and to better service you, our valued partners.

Our 2018 catalogue showcases Island Stone's latest designs, including updates and improvements on products that have proven successful over the years. All of us at Island Stone thank you for your continued support and look forward to many more years of partnership committed to excellence.



CONTENTS

1 NATURAL MOSAICS

Pebble

- 11 Perfect Pebble & Borders
- 12 King Pebble
- 13 Level Pebble
- 14 Petite Pebble
- 14 Celestial Pebble
- 15 Stacked Pebble
- 15 Strip Pebble

Random

- 19 Random Tile & Borders
- 21 Large Random Tile
- 22 Cobbles
- 23 Random Squares
- 23 Random Lines
- 23 Honeycomb Cobbles
- 23 Honeycomb Random

2 GLASS

Glass

- 31** Beach Tile Square /Rectangle & Trims
- 32** Strand
- 33** Spindrift
- 34** Waveline
- 35** Waveline Mini
- 36** Palms
- 37** Crossroads
- 37** Banyans
- 38** Artifact
- 38** Plaza
- 39** Linear
- 40** Boulevard
- 41** Streamline
- 41** Classic

3 QUARRIED STONE

Cladding

- 52** Strip
- 53** Mini Split
- 53** Briq
- 54** Parallels
- 55** Parallels V
- 56** Uniform
- 56** Cross Strips
- 57** Rustic
- 57** Rustic ii
- 58** V Squares
- 58** Slat Tile
- 59** Vtile
- 59** Vtile II
- 60** Large Vtile

Profile

- 64** Crescent Interlock
- 64** Crescent Mini Interlock
- 65** Crescent Vtile
- 65** Rhythm Interlock
- 66** Dunes
- 66** New Wave
- 67** Paragon Chevron
- 67** Paragon Hex

Mosaic

- 70** Classic Mosaic Squares
- 71** Avant Mosaic

Solid stone

- 75** Solid Square / Rectangle / Large Rectangle & trims

4 ISLAND TIMBER

Reclaimed Indonesian Teak

- 90** Papan Planks
- 91** Rimba
- 91** Kayu V-Wood

5 INSTALLATION INFORMATION

Information

- 94** Pebble & Random
- 96** Glass
- 97** Quarried Stone
- 99** VTile
- 100** Timber



Island Stone®

1 NATURAL MOSAICS

PEBBLE

THE HUMBLE BEAUTY OF A VOLCANIC PEBBLE WASHED AND WORN SMOOTH BY CRYSTAL CLEAR MOUNTAIN STREAMS INSPIRED OUR ICONIC PEBBLE TILE. WHY NOT BORROW FROM THE RIVER'S CLEAN DESIGN TO CREATE A SENSE OF SERENITY IN OUR STRUCTURES THAT MIRRORS THE NATURAL WORLD?

With the mantra "Many picked. Few chosen!" in mind, we source stones from a myriad of exotic locations and sort them by color and shape. Then, the pebbles are meticulously hand placed into interlocking patterns that imbue them with nature's effortless tranquility.

Evenly surfaced and easily installed, our elegant Pebble Series has proved itself as the mainstay of our business for many years. It isn't hard to see why: the pebble embodies durability and timelessness, without ever sacrificing the beauty of simplicity.





PERFECT PEBBLE

I3

11 3/4" x 11 3/4"

Pebble size: 1 1/2" - 3" *pd, pv (larger)

Pebble depth: 1/2"

Interlocking tile.

Tile surface: Natural

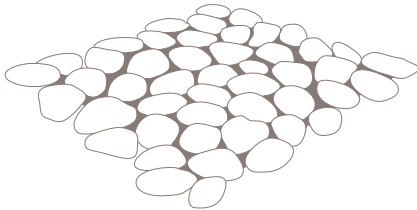

PEBBLE BORDERS

6" BORDER TILE - B3

6" x 11 3/4"

4" BORDER TILE - B4

4" x 11 3/4"

Pebble size: 3/4" - 1 1/4"

Pebble depth: 1/2"

Interlocking borders

Tile surface: Natural

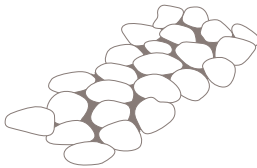
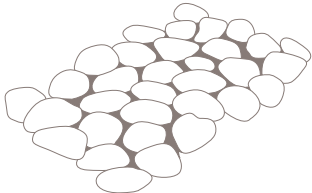

Antique Timor White
PM



French Tan
PF



Tundra Sage
PD



Birds Egg Blend
PV



Poppy Seed Blend
PY



Native Earth Blend
PN



Sumba Speckled
PS

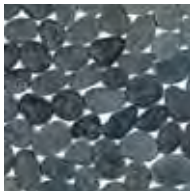

Medan Charcoal
PC



Alpine
PZ



Java Grey
PR



Nightcaps
PO



Black & Tan Mix
PA



KING PEBBLE

I4

15 3/4" x 15 3/4"

Pebble size: 3" - 5"

Pebble depth: 1/2"

Interlocking tile.

Tile surface: Natural

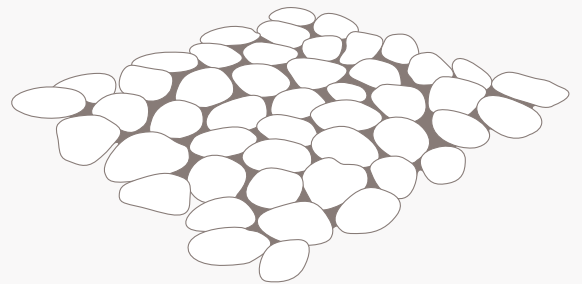

Antique Timor White
PM



French Tan
PF



Flores Green
PG



Java Grey
PR



Medan Charcoal
PC



LEVEL PEBBLE

FP1

11 3/4" x 11 3/4"
Pebble size: 1/2" - 2 1/2"
Pebble depth: 1/2"

Interlocking tile.
Tile surface: Honed

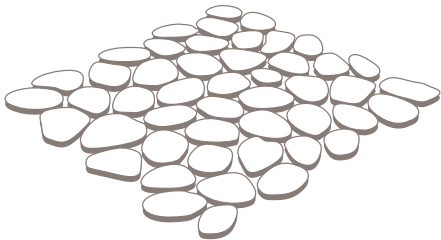

Antique Timor White
PM



French Tan
PF



Java Grey
PR



Medan Charcoal
PC



Malu Grey
PH



Birds Egg Blend
PV



Poppy Seed Blend
PY



Black & Tan Mix
PA

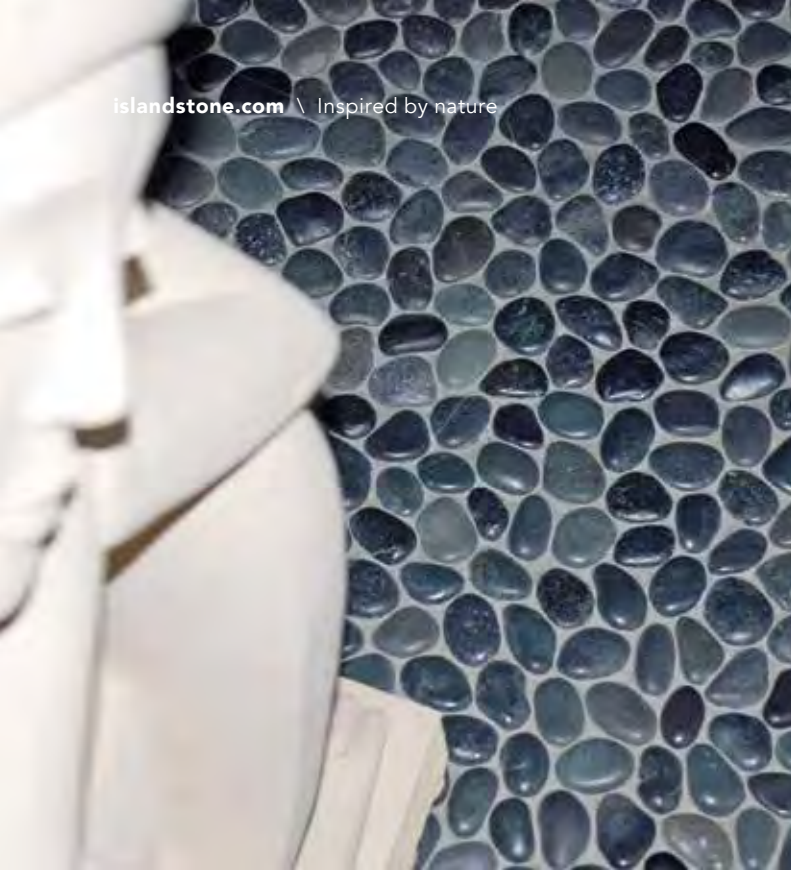

PETITE PEBBLE

IB3

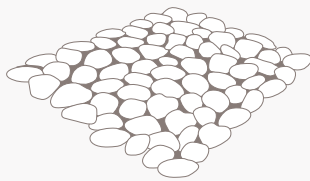

11 3/4" x 11 3/4"
Pebble size: 3/4" - 1 1/4"
Stone depth: 1/2"

Interlocking tile.
Tile surface: Natural



Antique Timor White
PM

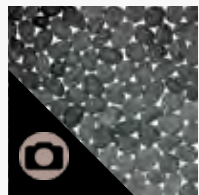

Medan Charcoal
PC

CELESTIAL PEBBLE

IB4

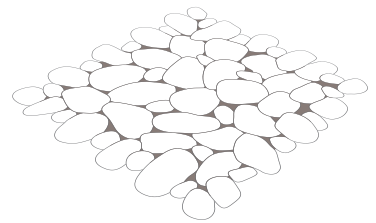

15 3/4" x 15 3/4"
Pebble size: 2" - 3" & 3/4"
- 1 1/4"
Pebble depth: 1/2"

Interlocking tile.
Tile surface: Natural



Antique Timor White
& Medan Charcoal
CW



French Tan & Medan
Charcoal
CT



Flores Green & Antique
Timor White
CG



Medan Charcoal
& French Tan
CB



STACKED PEBBLE

V1

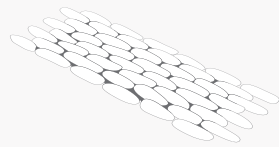

11 3/4" x 6"
Pebble size: 2" - 3/4"
Pebble depth: 1"

Interlocking tile.
Tile surface: Natural



Antique Timor White
PW



French Tan
PF



Medan Charcoal
PC

STRIP PEBBLE

SP1

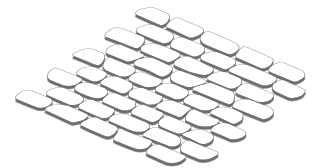

11 3/4" x 11 3/4"
Pebble size: 2" - 3" X 1 1/4"
Pebble depth: 1/2"

Interlocking tile.
Tile surface: Natural



Alpine
PZ

RANDOM

MANY YEARS AGO, WHILE DESIGNING A NEW RANGE OF TILES, A STAFF MEMBER EXCLAIMED “ACAK,” THE INDONESIAN WORD FOR “RANDOM.” THUS, THE NAME WAS COINED AND SINCE THAT DAY, OUR RANDOM SERIES HAS GROWN TO BE ONE OF OUR MOST POPULAR BRANDS.

Building the tile is a much like putting together an intricate jigsaw puzzle: the big picture only reveals itself once the last, perfectly selected piece has been inserted.

Once the craftsman places that ultimate piece and is satisfied with the final design, our quality assurance process goes to work.

We ensure almost 100% consistency in terms of color, size and thickness with each tile. It is truly random in name only!

Discover why our Random Tile Series continues to bring life to the finest hotels and residences in the world.





RANDOM TILE

I3

11 3/4" x 11 3/4"
Stone size: 1" - 3"
Stone depth: 1/2"
Interlocking tile.
Tile surface: Cut & Tumbled

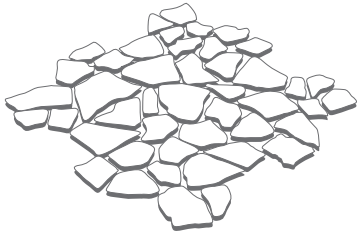

RANDOM BORDERS

6" BORDER TILE - B3
6" x 11 3/4"

Stone size: 1/2" - 1 1/2"
Stone depth: 1/2"

4" BORDER TILE - B4
4" x 11 3/4"

Interlocking borders
Tile surface: Cut & Tumbled

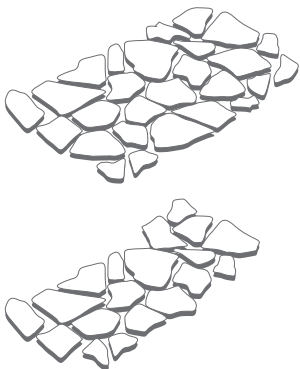

White Marble
RW



White Onyx
RZ



Beige Marble
MB



Latte Quartz
QB



Grey Marble
MA



Honey Quartz
QH



Mixed Quartz
QX



Tan Marble
MX



Swirl Grey
MM



Sterling Grey
ML



Black Basalt
MZ



Beige Marble &
Quartz Mix
MQ



Beige & Tan
Marble mix
MW



French Mix
XF



Swirl Grey &
Beige Mix
XK



Sterling Grey &
Grey Mix
XO



Sterling Megamix
XL



Tan & Grey
Marble Mix
MG



Honey Forest Mix
XH



Marble & Quartz
Megamix
XX

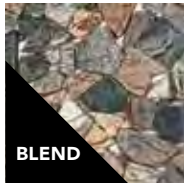

Forest Marble Mix
FX



LARGE RANDOM TILE

I5

17 3/4" x 17 3/4"
Stone size: 2" - 5"
Stone depth: 1/2"

Interlocking tile.
Tile surface: Cut & Tumbled

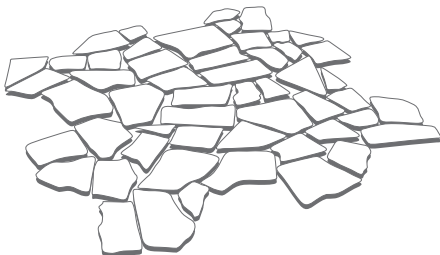

White Marble
RW



Beige Marble
MB



Tan Marble
MX



Grey Marble
MA

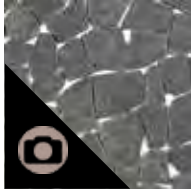

Black Basalt
MZ



BLEND

Sterling Megamix
XL



BLEND

Beige & Tan
Marble mix
MW



BLEND

Forest Marble Mix
FX



COBBLES

RP3

11 3/4" x 11" 3/4"
Stone size: 1" - 2"
Stone depth: 1/2"

Interlocking tile.
Tile surface: Honed Stone

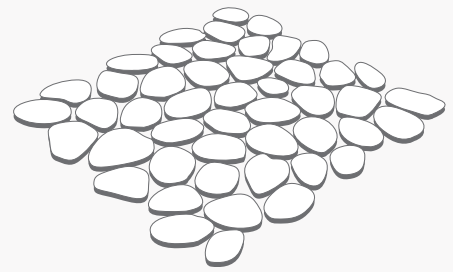

Beige Marble
MB



Latte Quartz
QB



Swirl Grey
MM



Sterling Grey
ML



Grey Marble
MA



Tan Marble
MX



Swirl Grey & Beige Mix
XK



Sterling Grey & Grey Mix
XO



Quartz & Sterling Grey Mix
XI



Multi Grey & Quartz Mix
XJ



Beige & Tan Marble
MW



Sterling Megamix
XL



RANDOM SQUARES

RS3

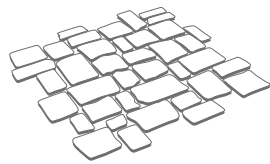

11 3/4" x 11 3/4"
Stone size: 1" - 2"
Stone depth: 1/2"

Interlocking tile.
Tile surface: Cut & Tumbled

RANDOM LINES

SR1

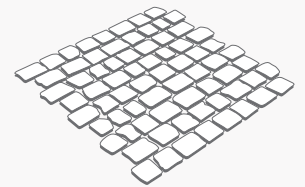

11 3/4" x 11"
Stone size: 1" - 1 1/2"
Stone depth: 1/2"

Interlocking tile.
Tile surface: Honed Stone



Beige Marble
MB



Grey Marble
MA



Tan Marble
MX

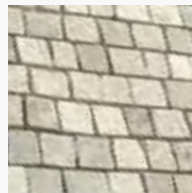

Beige Marble
MB

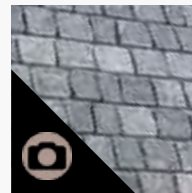

Grey Marble
MA



Stirling Grey
ML

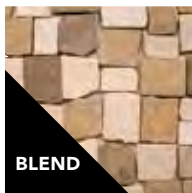

Beige & Tan Marble
MW



Marble & Quartz
Megamix
XX



French Mix Marble
XF

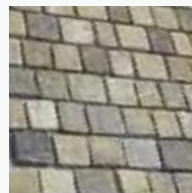

Tan Marble
MX



Beige & Tan Marble
MW



Sterling Megamix
XL



HONEYCOMB COBBLES

HC3

Length (tip to tip) 11 3/4"

Stone size: 1" - 3"

Stone depth: 1/2"

Hexagon tile with halo
edging.

Tile surface: Halo Edging

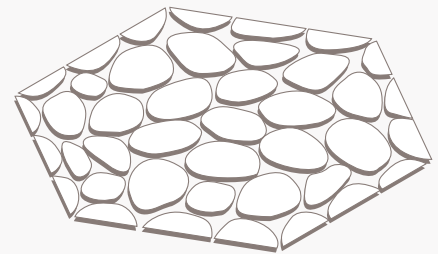

Beige Marble
MB

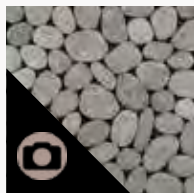

Sterling Grey
ML



Grey Marble
MA



Tan Marble
MX



Sterling Megamix
XL



Beige & Tan Marble
MW



Grey Mix
MLMA



Beige & Tan Marble
MXMB



Quartz & Tan Mix
QBMX



HONEYCOMB RANDOM

HR3

Length (tip to tip) 11 3/4"
Stone size: 1" - 3"
Stone depth: 1/2"

Hexagon tile with halo edging.
Tile surface: Halo Edging

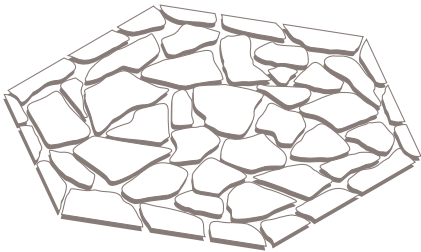

Beige Marble
MB



Sterling Grey
ML



Grey Marble
MA



Tan Marble
MX



Beige & Tan Marble
MW



Sterling Megamix
XL



Island Stone®

2 GLASS

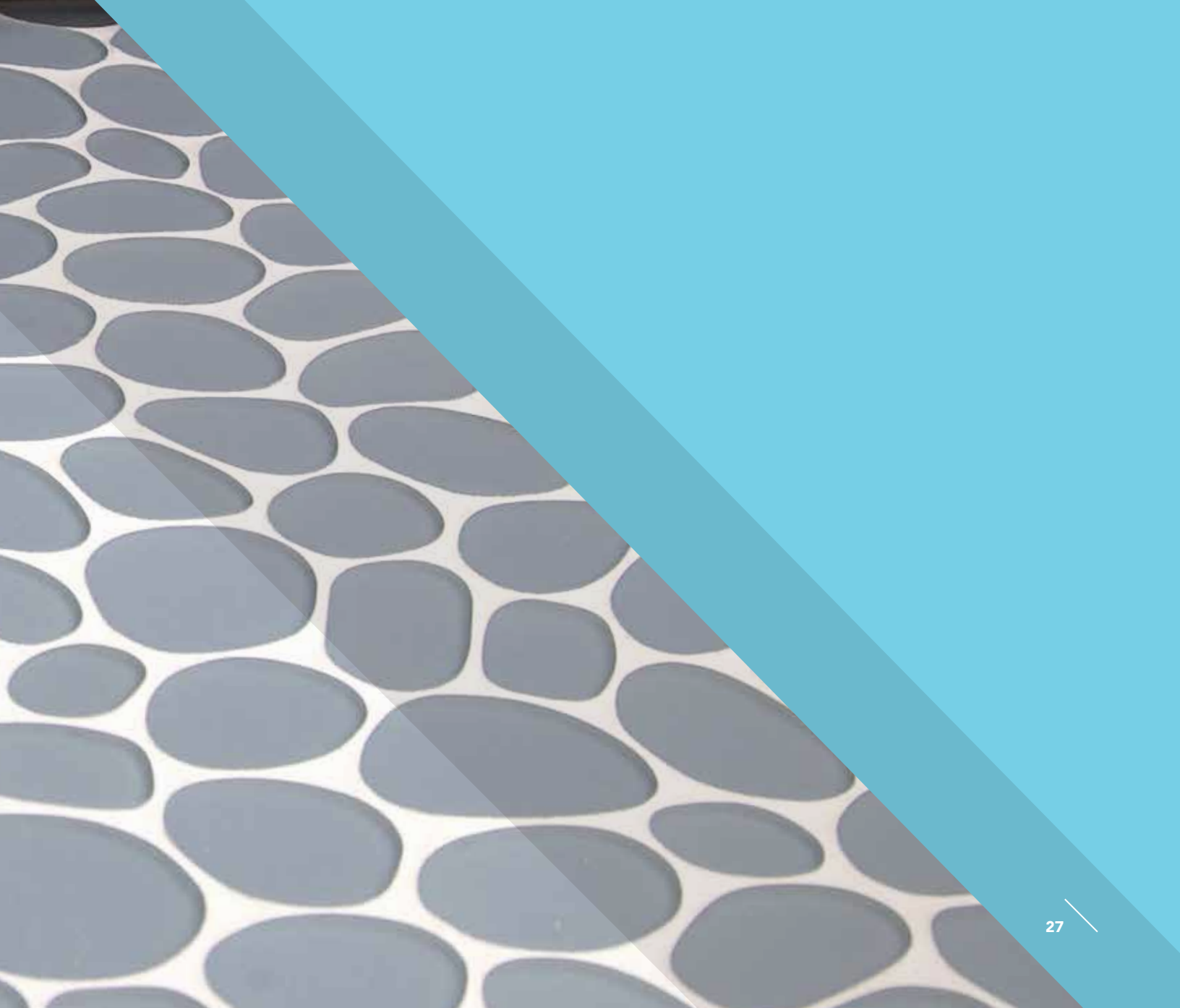

GLASS

WE DRAW INSPIRATION FOR OUR GLASS SERIES FROM PATTERNS FOUND IN NATURE, LIKE THE DELICATE SYMMETRY OF PALM FRONDS OR THE SLEEK LINEAR SHAPE OF THE BANYAN TREE.

Island Stone has embraced glass as a medium with inexhaustible potential. We are continually experimenting and innovating this series, and are thrilled to provide an extensive list of options that will bring a grace and lightness to your space.

Glass tile has an elegant air of subtlety, yet it can transform a wall or a room into a memorable piece of art.





BEACH TILES

SQUARE - S1

4" x 4"
9 pieces/sqft
Tile depth: 1/4"
Tile surface: Beach Texture
Individual tile.

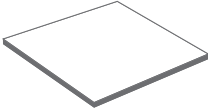

RECTANGLE - R2

4" x 8"
4.5 pieces/sqft
Tile depth: 1/4"
Tile surface: Beach Texture
Individual tile.

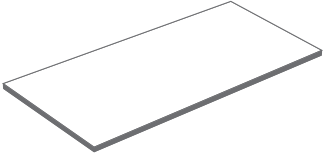

PENCIL BAR

TR1
7/8" x 8"
Tile surface: Matte

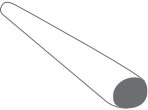

EXTERNAL RIGHT ANGLE

TR4
0.1" x 0.1" x 8.0" x 0.3"
Tile surface: Textured

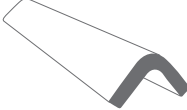



STRAND RECTANGLE

R3

3 5/8" x 12 1/8"
3.3 pieces/sqft
Tile depth: 1/4"

Tile surface: Beach Texture
& Gloss
Individual tile.

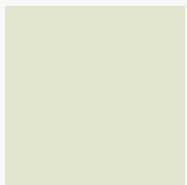
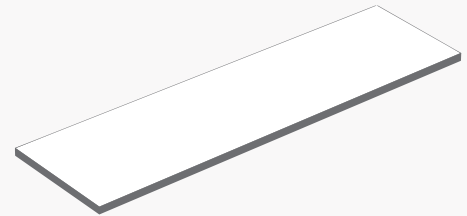

Champagne



Frangipani



Reed

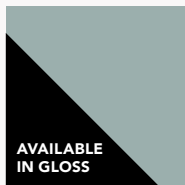

Breeze

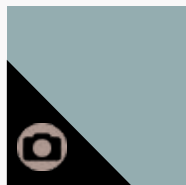

Stratos

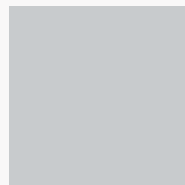

Tule



Smoke

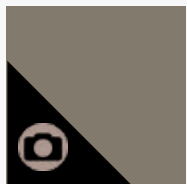

Cement

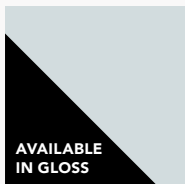

Pure Silk



Oceania



Azure



Margarita



Ginger



SPINDRIFT

BG14

12" x 12"
Tile depth: 3/16"

Tile surface: Matte
Pre-formatted mosaic tile

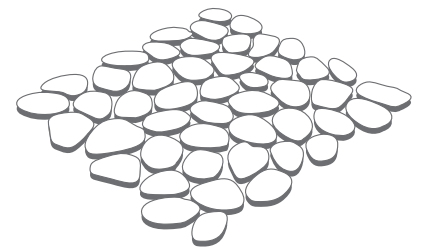

Stratos

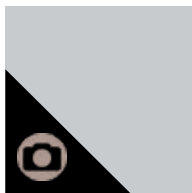

Tule



Smoke

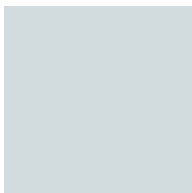

Pure Silk



Azure



Spring



WAVELINE

BG4

12 1/2" x 12 3/4"
0.9 pieces/sqft
Tile depth: 3/16"

Tile surface: Matte
Interlocking tile.

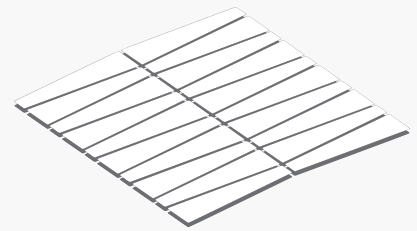

Guava

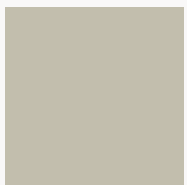

Frangipani



Seagrass



Reed

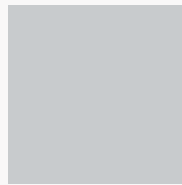

Tule



Smoke



Cement

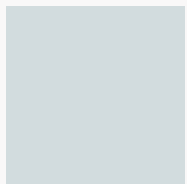

Pure Silk

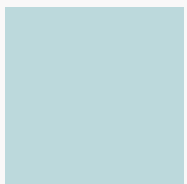

Oceania



Azure



Spring



Margarita

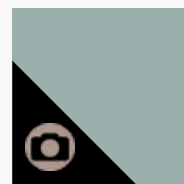

Breeze



WAVELINE MINI

BG9

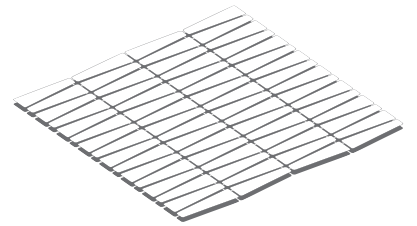

12 1/4" x 12 3/4"
Tile depth: 3/16"

Tile surface: Matte & Gloss
Interlocking tile



Sand

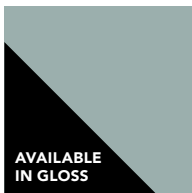

Breeze



Stratos

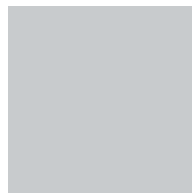

Tule

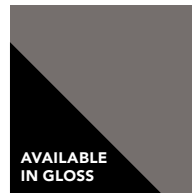

Smoke

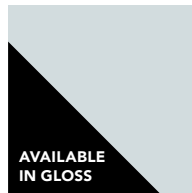

Pure Silk

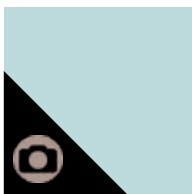

Oceania

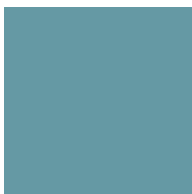

Azure



Spring



Margarita



Fresh



PALMS

BG11

9 1/4" x 11 3/4"
1.25 pieces/sqft
Tile depth: 3/16"

Tile surface: Matte
Interlocking tile.

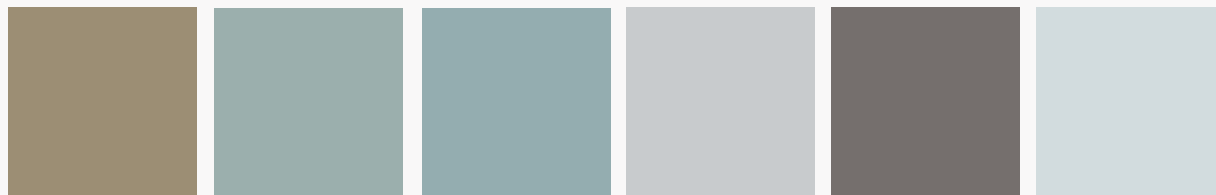
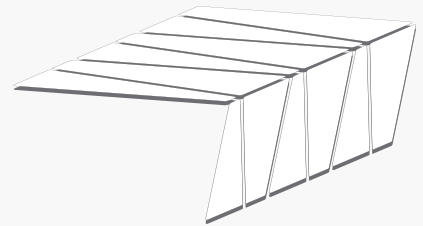

Sand Breeze Stratos Tule Smoke Pure Silk



Oceania Azure Lagoon Spring Margarita



CROSSROADS

BG13

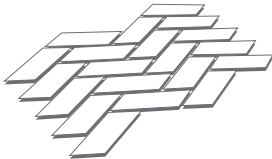

9 1/4" x 16"
1.0 piece/sqft
Tile depth: 3/16"

Tile surface: Matte
Interlocking tile.



Sand

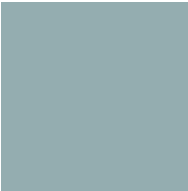

Stratos



Smoke

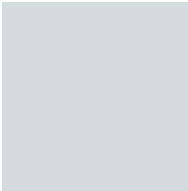

Pure Silk

BANYANS

BG12

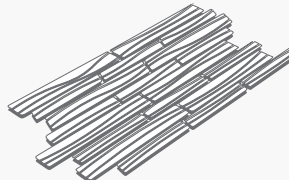

8 1/2" x 16 1/4"
1.0 piece/sqft
Tile depth: 3/16"

Tile surface: Gloss with line texture.
Interlocking tile.



Frangipani

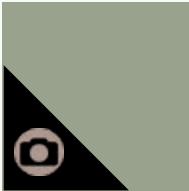

Reed



Smoke

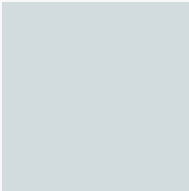

Pure Silk



ARTIFACT

BG6

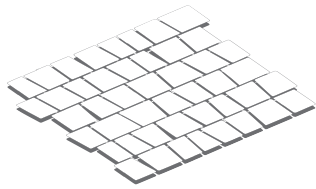

11" x 11 1/2" x 1/4"
1.0 piece/sqft

Interlocking tile.
Tile surface: Matte



Seagrass

Stratos

Smoke

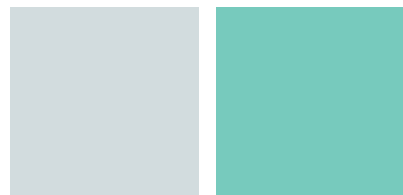

Pure Silk

Spring

PLAZA

BG10

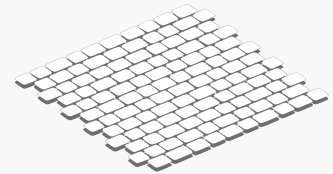

11 3/4" x 12" x 1/4"
1.0 piece/sqft
Tile depth: 1/4"

Tile surface: Matte
Interlocking tile.

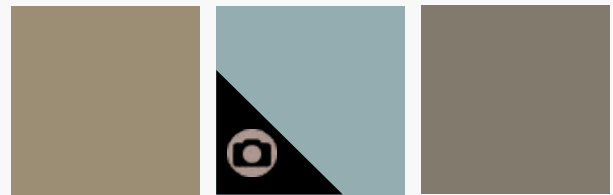

Sand

Stratos

Cement

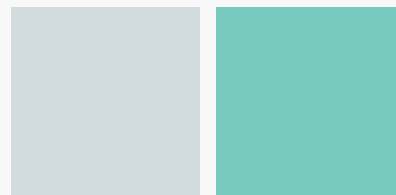

Pure Silk

Spring



LINEAR

BG1

10 1/2" x 12 1/2"
1.1 pieces/sqft
Tile depth: 3/16"

Tile surface: Beach texture
Interlocking tile.

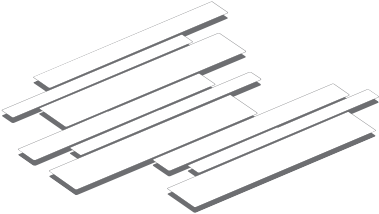

Sand



Frangipani



Seagrass

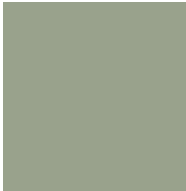

Reed



Breeze

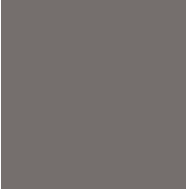

Smoke



Cement

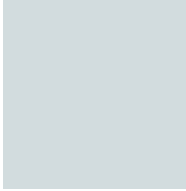

Pure Silk



BOULEVARD

BG5

10 1/4" x 12 1/2"
1.1 pieces/sqft
Tile depth: 1/4"

Tile surface: Beach texture
and gloss
Interlocking tile.

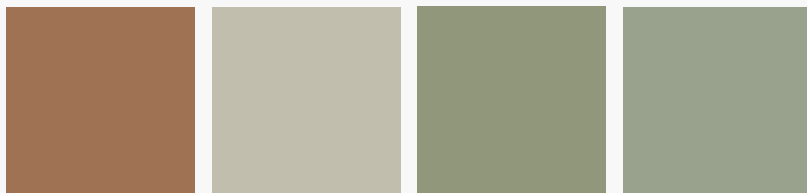
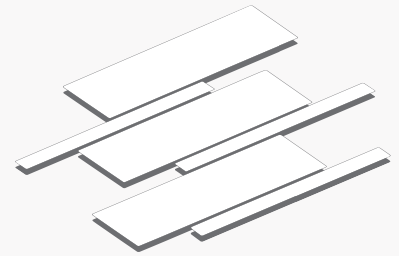

Guava

Frangipani

Seagrass

Reed



Breeze

Smoke

Cement

Pure Silk



STREAMLINE

BG8

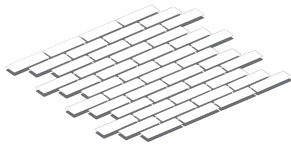

11 3/4" x 12"
1.0 piece/sqft
Tile depth: 3/16"

Tile surface: Beach texture
Interlocking tile.

CLASSIC

BG7

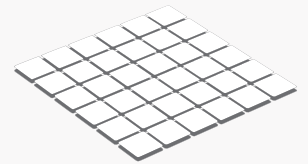

11 3/4" x 11 3/4"
1.0 piece/sqft
Tile depth: 1/4"

Tile surface: Beach texture
Square mosaic tile.



Frangipani

Reed

Breeze



Cement

Pure Silk



Frangipani

Reed

Breeze



Cement

Pure Silk

GLASS

FORMATS BY COLOR

Glass is incredibly versatile: it can be fused into a staggering variety of colors to suit the interiors of any room. We choose to represent the tones often found in nature, such as the sparkling turquoise of a clear lagoon or the rich toned hues of the earth.

This tile is our interpretation of the delicate vibrancy of sea-glass, customized to accent the color scheme of your unique space.



PURE SILK

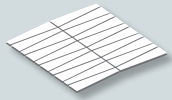

Waveline

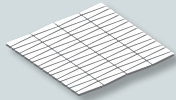

Waveline Mini
(Matte & Gloss)

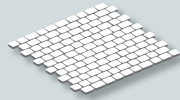

Plaza Mosaic



Linear Mosaic



Palms



Crossroads



Boulevard Mosaic

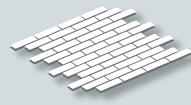

Streamline Mosaic

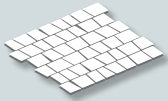

Artifact

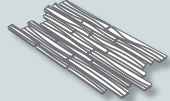

Banyans

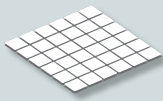

Classic Mosaic



Spindrift

CEMENT

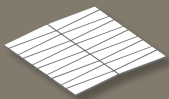

Waveline

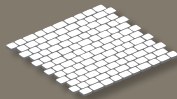

Plaza Mosaic

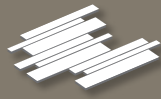

Linear Mosaic

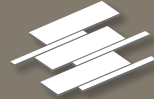

Boulevard Mosaic

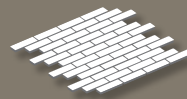

Streamline Mosaic

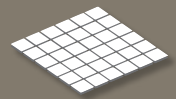

Classic Mosaic

SAND

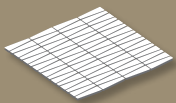

Waveline Mini

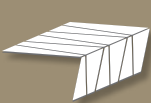

Palms



Crossroads

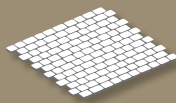

Plaza Mosaic

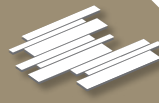

Linear Mosaic

TULE



Palms

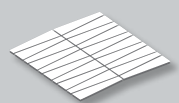

Waveline

REED

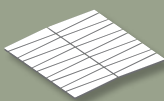

Waveline

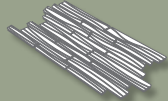

Banyans

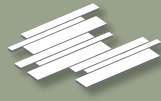

Linear Mosaic



Boulevard Mosaic

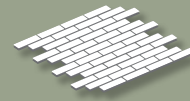

Streamline Mosaic

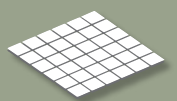

Classic Mosaic

FRANGIPANI

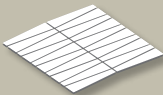

Waveline

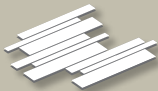

Linear Mosaic

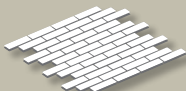

Streamline Mosaic

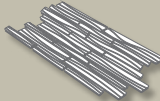

Banyans



Boulevard Mosaic

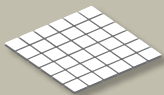

Classic Mosaic

BREEZE

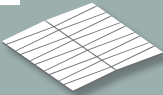

Waveline

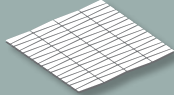

Waveline Mini
(Matte & Gloss)



Linear Mosaic



Palms



Boulevard Mosaic

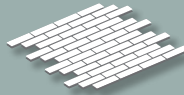

Streamline Mosaic

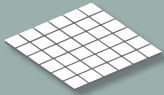

Classic Mosaic

SPRING

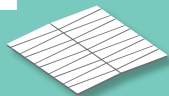

Waveline

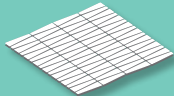

Waveline Mini



Palms



Plaza Mosaic



Artifact



Spindrift

STRATOS

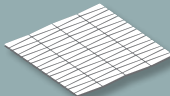

Waveline Mini

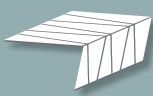

Palms



Crossroads

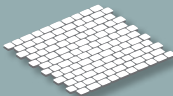

Plaza Mosaic

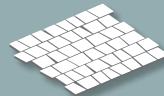

Artifact



Spindrift

SEAGRASS

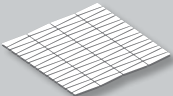

Waveline Mini



Spindrift

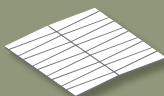

Waveline

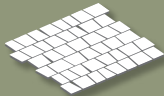

Artifact

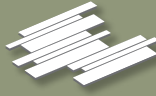

Linear Mosaic



Boulevard Mosaic

GUAVA

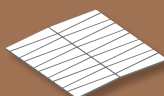

Waveline

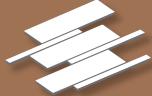

Boulevard Mosaic

FRESH

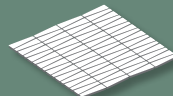

Waveline Mini

SMOKE

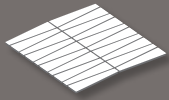

Waveline

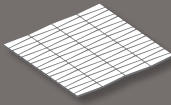

Waveline Mini
(Matte & Gloss)



Palms



Crossroads

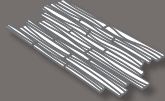

Banyans

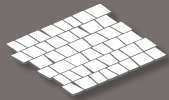

Artifact



Linear Mosaic



Boulevard Mosaic

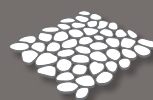

Spindrift



MAGARITA

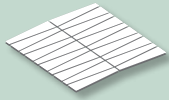

Waveline

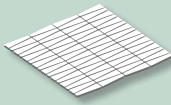

Waveline Mini



Palms

AZURE

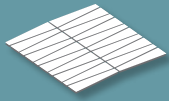

Waveline

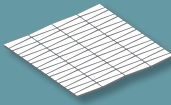

Waveline Mini

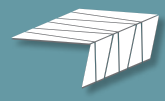

Palms



Spindrift

OCEANIA

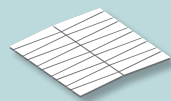

Waveline

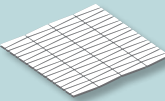

Waveline Mini

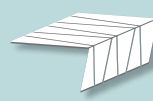

Palms

LAGOON

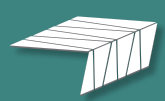

Palms





Island Stone[®]

3 QUARRIED STONE

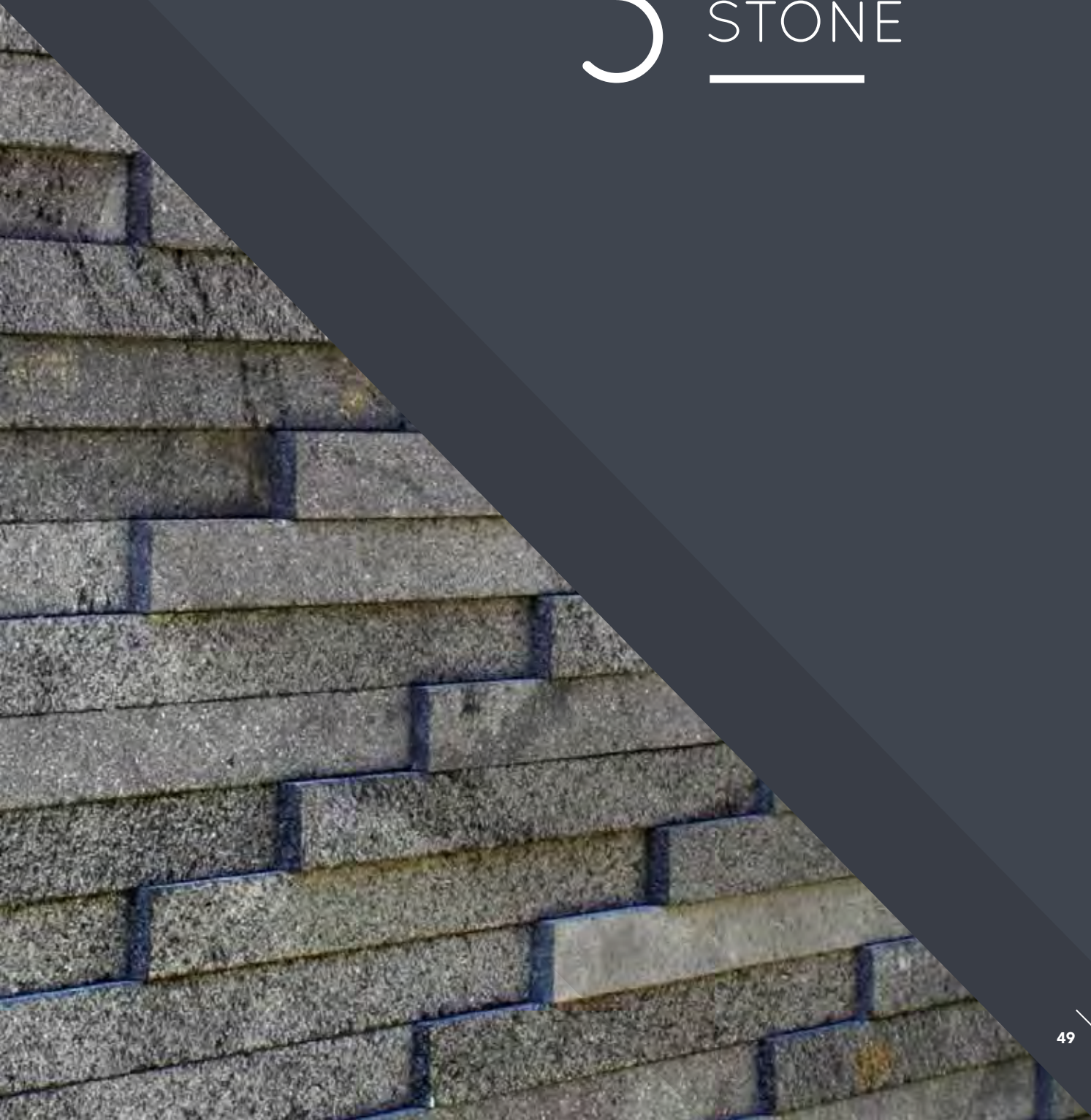

CLADDING

RAW CUT STONE IS BOTH STRIKING AND ENDURING, MAKING IT THE IDEAL MATERIAL FOR EXTERIOR CLADDING SURFACES OR RUSTIC INDOOR INSTALLATIONS.

At Island Stone, we first recognized the power of raw stone when individual pieces were placed together to create a dramatic finished surface. Realizing its potential, we slowly perfected the art of precision-cutting every piece and fitting the

stones together with the utmost attention to detail.

The beauty of this series lies in the individual textures, colors, and weight of each stone, which integrate to create a vivid masterpiece.





STRIP

CS1

2" x 11 3/4"

Stone depth: 3/8"

Tile surface: Split face/Craftline/Distressed

Individual rectangular tile.

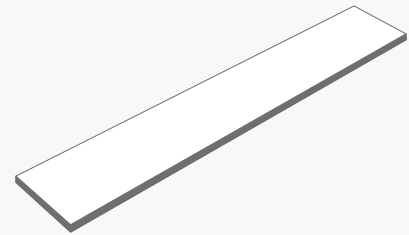

Himachal White
HW



Sandstone Mint
SM



Golden Slate
GD

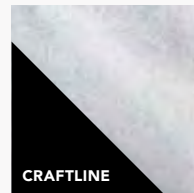

Rice White Marble
JW

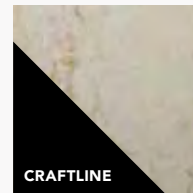

Bali Cream Marble
JC



Copper
Quartzitic Slate
QC



Silver
Quartzitic Slate
QS



Himachal Black
HB

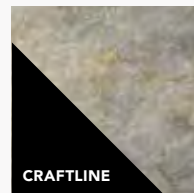

Exotic Sands Marble
JO

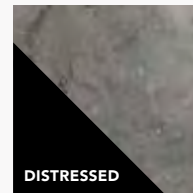

Volcano Grey Marble
JG



MINI SPLIT

CJ4

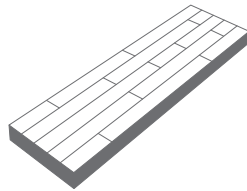

3" x 11 3/4"
Stone depth: 5/8"
Tile surface: Split face

Multi piece, glued rectangular tile.

BRIQ

CQ3

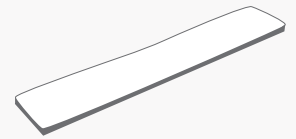

2.5" x 11 3/8"
Stone depth: 3/8"

Tile surface:
Honed natural face
Individual rectangular tile

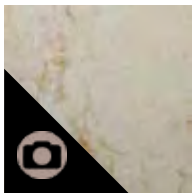

Budi Cream
JK

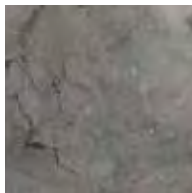

Volcano Grey Marble
JG



Sandstone Mint Mix
SX



Sandstone Grey
SG

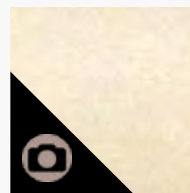

Tropical White
WP

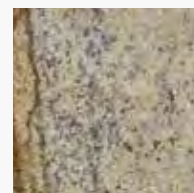

Tropical Tan
TP



PARALLELS

CL2

6 1/2" x 11 1/2"

Stone widths:

1 1/4", 1 7/8", 2 1/2"

Stone depth: 1/2"

Tile surface: Split face

Mesh backed interlocking tile.

Pre-formatted linear pattern.

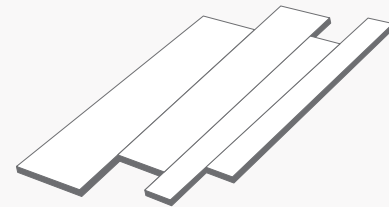

Himachal White
HW

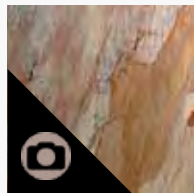

Golden Slate
GD

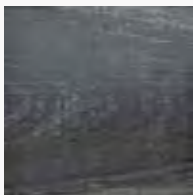

Sutra Black
BM

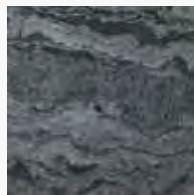

Silver
Quartzitic Slate
QS



PARALLELS V

CL3

6 1/2" x 22 3/4"
Stone widths:
1", 1 1/4", 1 7/8", 2 1/2"
Stone depth: 3/8" - 7/8"

Tile surface: Honed/split face
Mesh backed interlocking tile.
Pre-formatted wedge/strip design.

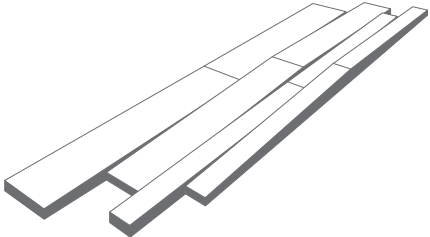

Rice White Marble
JW



Bali Cream Marble
JC



Exotic Sands Marble
JO



Volcano Grey Marble
JG



Tropical White
WP



Golden Slate
GD



Silver
Quartzitic Slate
QS

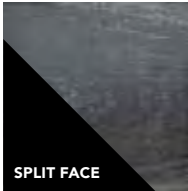

Sutra Black
BM



UNIFORM

CL1

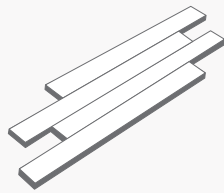

4 3/4" x 15 3/8"
Stone size: 1 1/2" x 15 3/8"
Stone depth: 3/8" - 7/8"

Tile surface: Chipped
Mesh backed interlocking tile.
Pre-formatted linear pattern.



Sandstone MInt
SMC

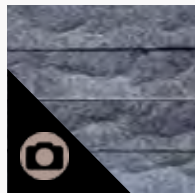

Grey Andesite
AGC

CROSS STRIPS

CX1

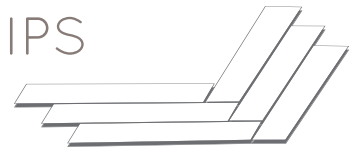

5 5/8" x 20 7/8"
Stone size: 1 7/8" x 10 1/2"
Stone depth: 1/2"

Tile surface: Split Face
Mesh backed interlocking
tile with pre-formatted
wedge relief.



Himachal White
HW



Golden Slate
GD



Silver
Quartzitic Slate
QS



RUSTIC

CR1

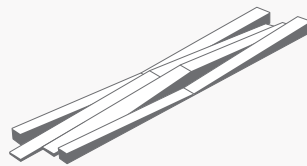

4" x 22 3/4"
 Stone size: 1" x 11 1/2"
 Stone depth: 3/8" - 7/8"
 Tile surface: Split face

Mesh backed interlocking tile.
 Pre-formatted wedge design.

RUSTIC II

CR5

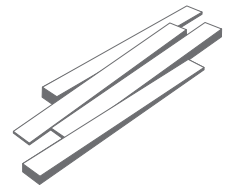

4 3/4" x 15 3/8"
 Stone size: 1 1/4" x 15 3/8"
 Stone depth: 3/8" - 7/8"
 Tile surface: Honed/flamed

Mesh backed interlocking tile.
 Pre-formatted wedge design.



Sandstone Mint
SM



Sandstone Grey
SG



Golden Slate
GD

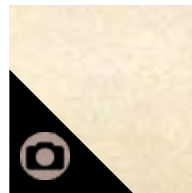

Tropical White
WP



Sandstone Grey
SG



Tropical Tan
TP

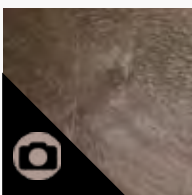

Copper
Quartzitic Slate
QC



Silver
Quartzitic Slate
QS

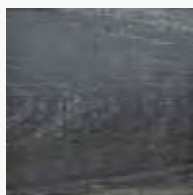

Sutra Black
BM



Island Sage
CP



Flecked Andesite
(flamed) **AKF**



Temple Lava
BL



V SQUARES

CV1

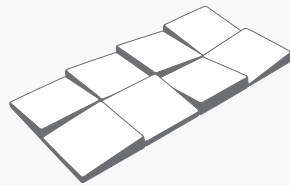

15 1/2" x 7 3/4"

Stone size - 3 7/8" x 3 7/8"

Stone depth: 3/8" - 7/8"

Tile surface - Honed

Mesh backed tile.

Pre-formatted wedge design.

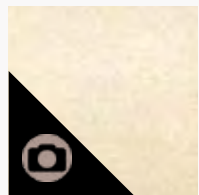

Tropical White
WP

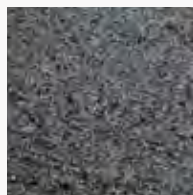

Temple Lava
BL

SLAT TILE

CT2

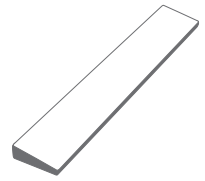

2" x 11 3/4"

Stone depth: 3/8" - 7/8"

Tile surface: Honed

Individual rectangular tile.
Inspired by VTile, offering
wedge relief with angle cut
across short width.

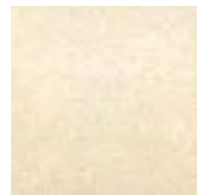

Tropical White
WP

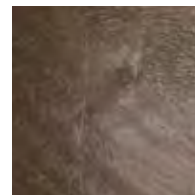

Copper
Quartzitic Slate
QC

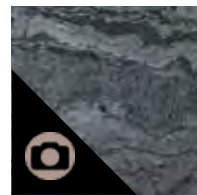

Silver
Quartzitic Slate
QS



VTILE

CR2

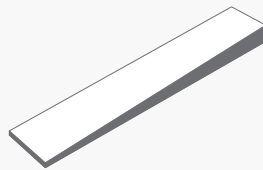

2" x 11 1/2"
Stone depth: 3/8" - 7/8"

Tile surface: Split face
Individual rectangle with
wedge relief.

VTILE II

CR7

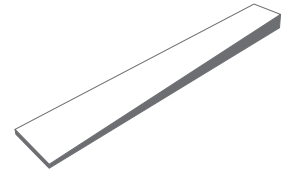

2" x 15 3/8"
Stone depth: 3/8" - 7/8"

Tile surface: Honed / flamed
Individual rectangle with
wedge relief.



Sandstone Mint
SM

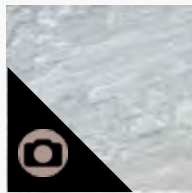

Sandstone Grey
SG



Golden Slate
GD

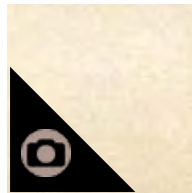

Tropical White
WP



Temple Lava
BL

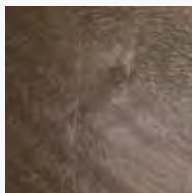

Copper
Quartzitic Slate
QC



Silver
Quartzitic Slate
QS

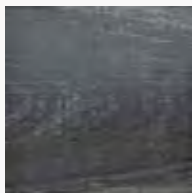

Sutra Black
BM



LARGE VTILE

CR4

4" x 15 3/8"

Stone depth: 3/8" - 7/8"

Tile surface: Split face
/ Honed / Flamed

Individual rectangle with
wedge relief

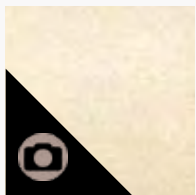
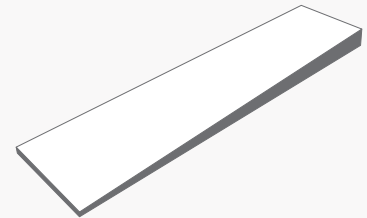

Tropical White
WP



Sandstone Mint
SM



Sandstone Grey
SG

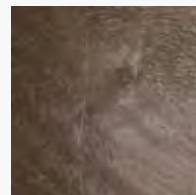

Copper
Quartzitic Slate
QC



Golden Slate
GD



Temple Lava
BL



Silver
Quartzitic Slate
QS

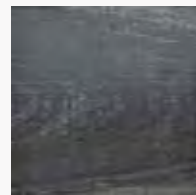

Sutra Black
BM



PROFILES

OUR PROFILES SERIES SEAMLESSLY
COMBINES THOUGHTFUL ENGINEERING
AND AVANT-GARDE DESIGN.

We build eye-catching reliefs by cutting stone into various exact shapes, honing their surfaces, and matching the honed pieces together to create an interlocking system. The rendering often appears 3-dimensional, even sculptural.

A Profile wall elevates texture beyond the traditional limits of stone tile, blurring the line between design and fine art.



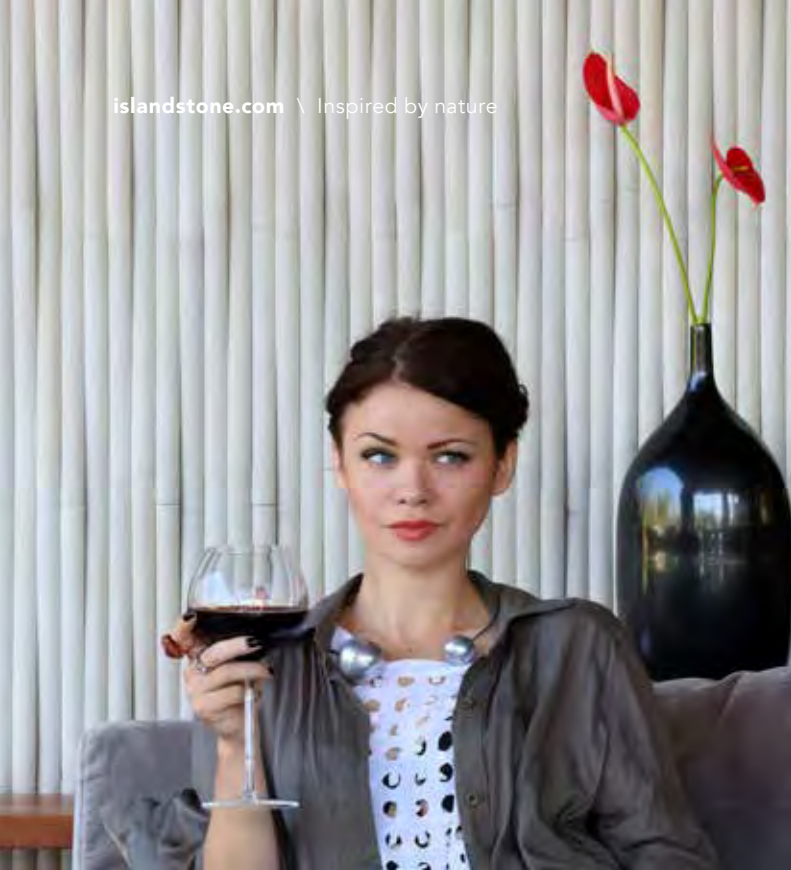

CRESCENT INTERLOCK

CB1

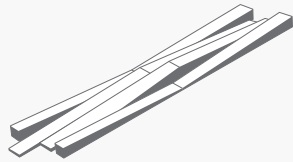

4" x 22 3/4"
Stone depth: 3/8" - 7/8"
Stone size: 1" x 11 3/8"

Interlocking wedge tile.
Tile surface: Honed



Sandstone Mint
SM



Silver
Quartzitic Slate
QS

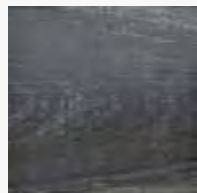

Sutra Black
BM

CRESCENT MINI INTERLOCK

CB3

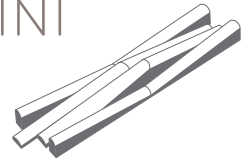

11 7/8" x 3 1/4"
Stone depth: 3/8" - 7/8"
Stone size: 3/4" x 5 7/8"

Interlocking wedge tile.
Tile surface: Honed



Sandstone Mint
SM



Silver
Quartzitic Slate
QS

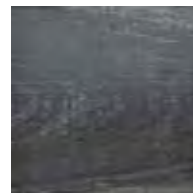

Sutra Black
BM



CRESCENT VTILE

CB2

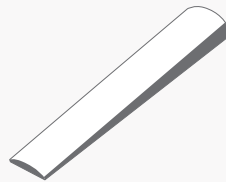

2" x 11 1/2"
Stone depth: 3/8" - 7/8"

Individual Wedge tile
Tile surface: Honed



Sandstone Mint
SM



Silver
Quartzitic Slate
QS

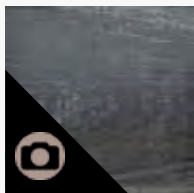

Sutra Black
BM

RHYTHM INTERLOCK

MW3

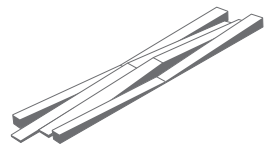

15 3/8" x 3 1/8"
Stone depth: 3/8" - 7/8"
Stone size: 15 3/8" x 3/4"

Interlocking wedge tile.
Tile surface: Honed



Sandstone Mint
SM

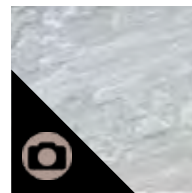

Sandstone Grey
SG

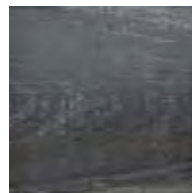

Sutra Black
BM



DUNES

DP1

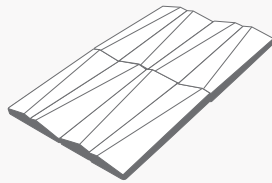

7 1/2" x 11 7/8"
Stone depth: 1/4" - 5/8"
Stone size: 1 7/8" x 5 7/8"

Meshed back interlocking tile with pre-formatted wedge relief
Tile surface: Honed

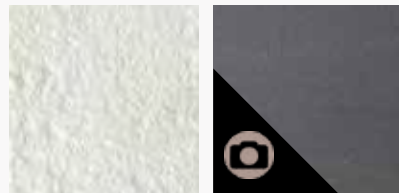

Sandstone Mint
SM

Sandstone Ocean
SO

NEW WAVE

MW2

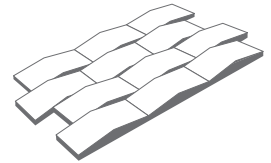

7 1/2" x 11 1/4"
Stone depth: 3/8" - 7/8"
Stone size: 3 3/4" x 1 7/8"

Interlocking Wedge tile
Tile surface: Honed

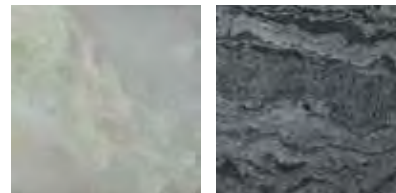

White Marble
RW

Silver Quartzitic Slate
QS

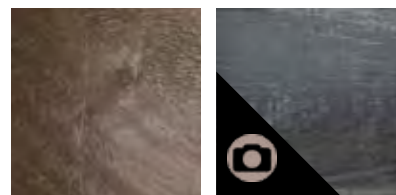

Copper Quartzitic Slate
QC

Sutra Black
BM



PARAGON CHEVRON

PP1

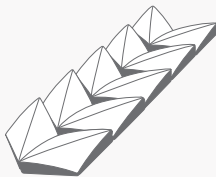

4" x 11 1/2"
Stone depth: 1/4" - 5/8"

Tile Surface: Honed
Meshed back interlocking
tile with pre-formatted
wedge relief



Sandstone Mint
SM

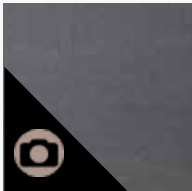

Sandstone Ocean
SO

PARAGON HEX

PP2

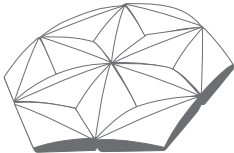

Hex: .38 sq.ft/piece
Stone depth: 1/4" - 5/8"

Tile Surface: Honed
Meshed back interlocking
tile with pre-formatted
wedge relief



Sandstone Mint
SM



Sandstone Ocean
SO

MOSAIC

OUR CRAFTSPEOPLE HONOR THE AGE-OLD TRADITION OF MOSAIC WITH THE SAME LEVEL OF PERFECTION, PRECISION, AND MODERN SENSIBILITY YOU HAVE COME TO EXPECT FROM ISLAND STONE.

We source materials from Indonesia and India, where our artists cut pieces of stone that are then laid out onto a mesh grid to create an easy-to-install single tile. Simple to cut, shape, and customize, this series is an Island Stone interpretation of a beloved classic.





CLASSIC MOSAIC SQUARES

M48

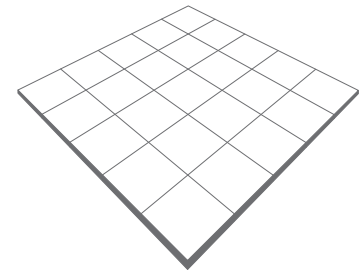

11 3/4" x 11 3/4"
Stone depth: 1/2"
Stone size: 1 7/8" x 1 7/8"

Pre-formatted Mosaic tile.
Tile surface: Honed/split face

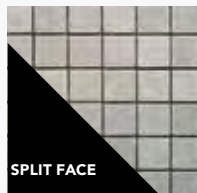

Himachal White
HW

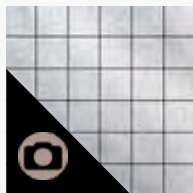

Rice White
JW

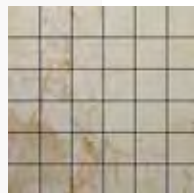

Bali Cream
JC

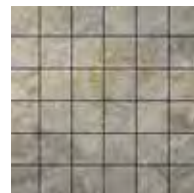

Exotic Sands Marble
JO



Volcano Grey Marble
JG

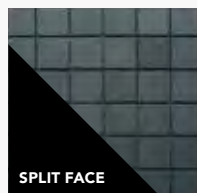

Himachal Black
HB

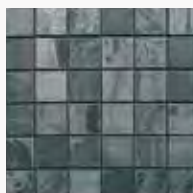

Silver
Quartzitic Slate
QS



Blend: QC/MB/MX
S10

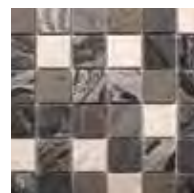

Blend: QS/AGH/
HW/HB
B10



AVANT MOSAIC

M22

11 3/4" x 11 3/4"
Stone depth: 1/4"
Stone size: 1 7/8" x 7/8"

Pre-formatted Mosaic tile.
Tile surface: Honed stone
& crinkled glass

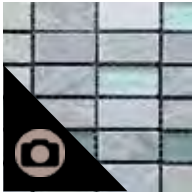
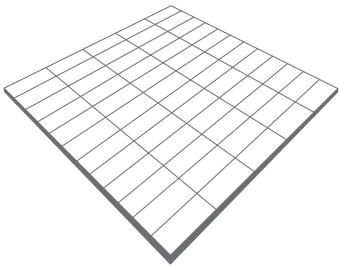

White Ocean
HW015



Copper Earth
QC13S



Silver Night
QS09S

QUARRIED STONE

BRING AN ELEMENTAL SIMPLICITY TO YOUR SPACE WITH SOLID QUARRIED STONE, A TILE THAT IMPLIES LUXURY WITHOUT AN OUNCE OF FUSSINESS.

Our solid stone series is ideal for outdoor and indoor installations with a rustic flair. Imagine showers, fireplaces, floors, and more elevated by the drama of quality stone.

The possibilities are truly limited only by your imagination.

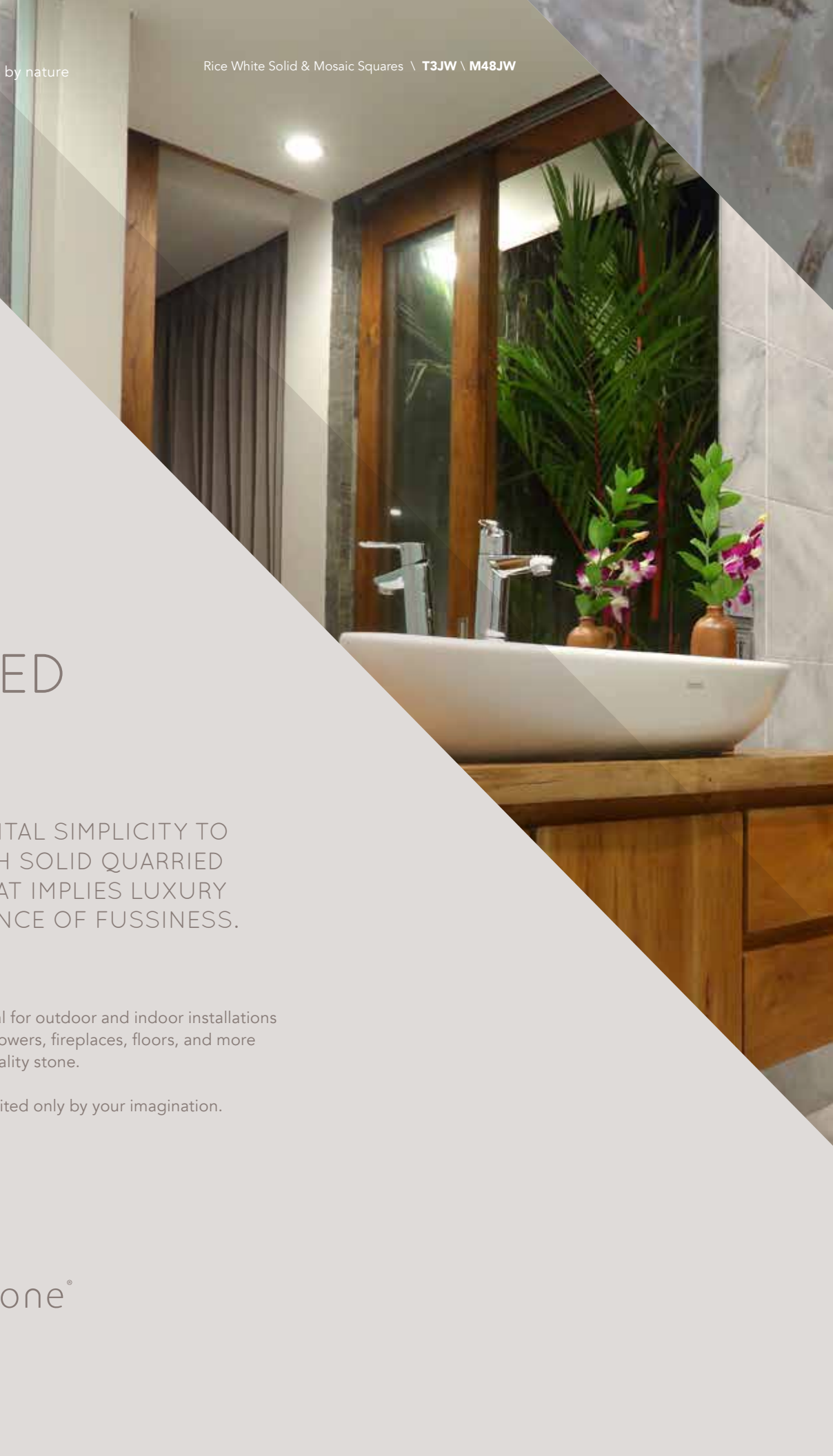





SOLID TILES

Our Solid Tile range comes in a selection of pre-cut sizes and trims.

TILES

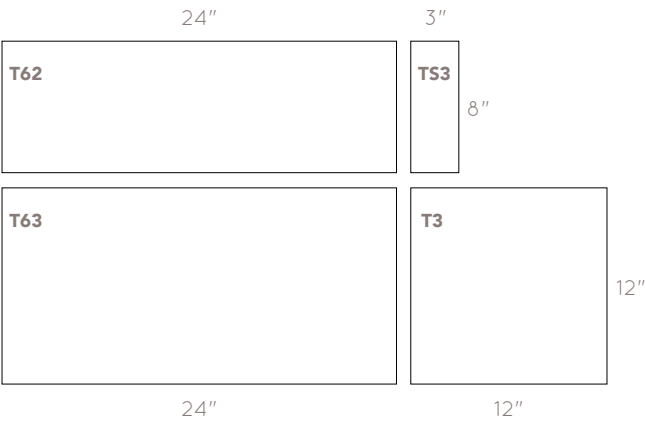

TRIMS

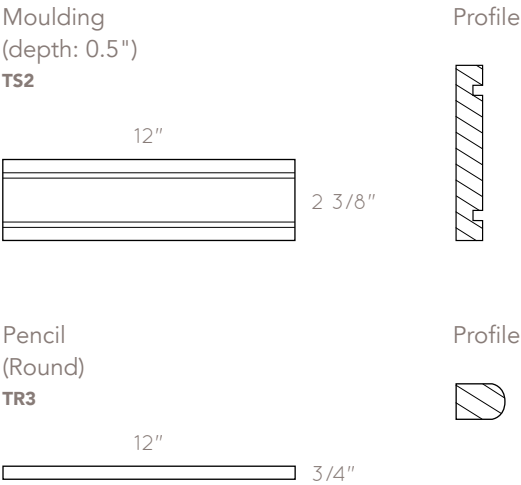

CUSTOM SIZES

Island Stone offers unmatched capability in working with customers on producing custom sized tiles. For more information see page 139 for additional information on Island Stone custom order capabilities.

RICE WHITE JW

Tile surface: Honed

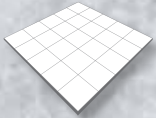

Classic Square
M48 (Page 70)



Craftline Strip
CS1 (Page 52)

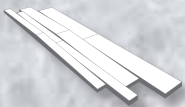

Parallels V
CL3 (Page 55)

SOLID STONE TILES

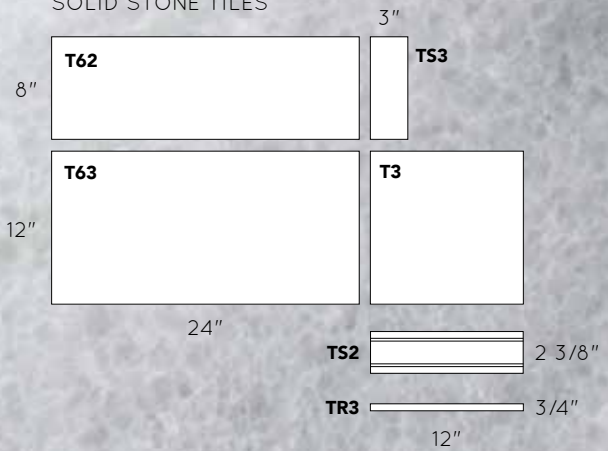

BALI CREAM JC

Tile surface: Honed

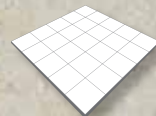

Classic Square
M48 (Page 70)



Craftline Strip
CS1 (Page 52)



Mini Split
CJ4 (Page 53)



Parallels V
CL3 (Page 55)

SOLID STONE TILES

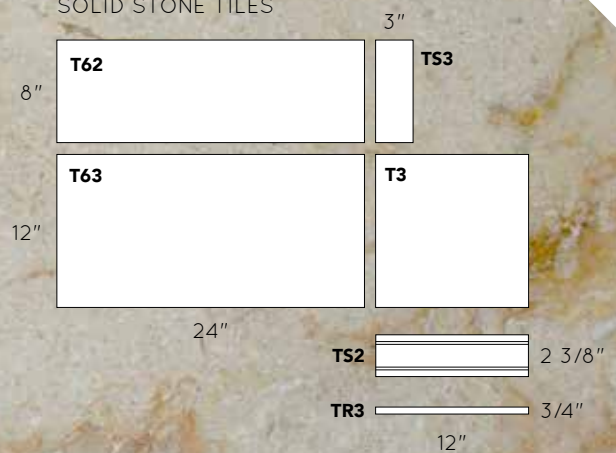

EXOTIC SANDS JO

Tile surface: Honed



Classic Square
M48 (Page 70)



Craftline Strip
CS1 (Page 52)



Parallels V
CL3 (Page 55)

SOLID STONE TILES

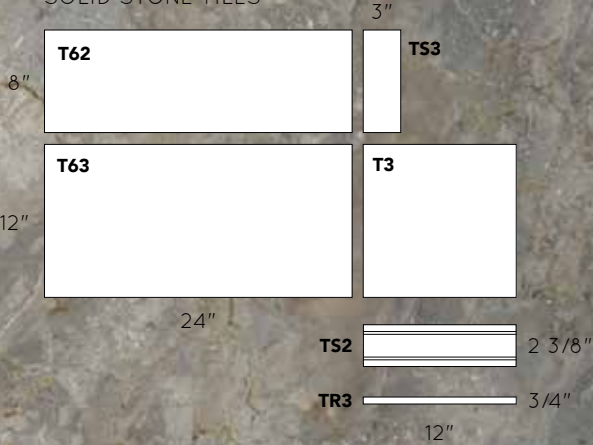

VOLCANO GREY JG

Tile surface: Honed

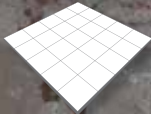

Classic Square
M48 (Page 70)



Distressed Strip
CS1 (Page 52)



Mini Split
CJ4 (Page 53)



Parallels V
CL3 (Page 55)

SOLID STONE TILES

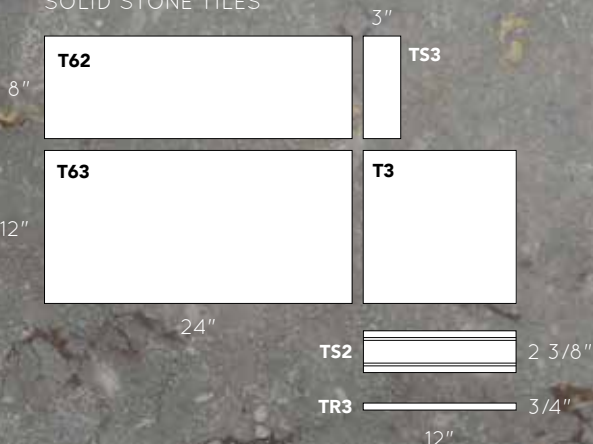

TROPICAL WHITE

WP

Tile surface: Honed



Rustic II
CR5 (Page 57)



Parallels V
CL3 (Page 55)

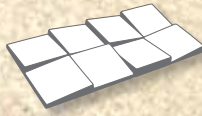

V Squares
CV1 (Page 58)



Briq
CQ3 (Page 53)



Slat
CT2 (Page 58)



VTile II
CR2 (Page 59)



Large VTile
CR4 (Page 60)

TROPICAL TAN

TP

Tile surface: Honed



Rustic II
CR5 (Page 57)



Briq
CQ3 (Page 53)

ISLAND SAGE

CP

Tile surface: Honed



Rustic II
CR5 (Page 57)

GREY ANDESITE

AKF / AGC

Tile surface: Flamed & Chipped

Solid Tile Sizes:

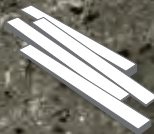

Rustic II
CR5 (Page 57)

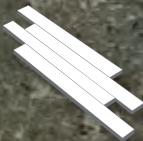

Uniform
CL1 (Page 56)

TEMPLE LAVA

BL

Tile surface: Honed

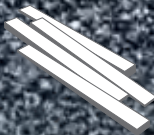

Rustic II
CR5 (Page 57)

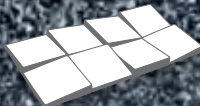

V Squares
CV1 (Page 58)



Vtile II
CR7 (Page 59)



Large Vtile
CR4 (Page 60)

SANDSTONE MINT SM

Tile surface: Split Face & Honed

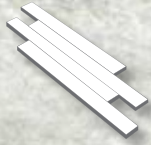

Uniform
CL1 (Page 56)



Rustic
CR1 (Page 57)



Crescent
Interlock
CB1 (Page 64)



Crescent
Interlock Mini
CB3 (Page 64)



Strip
CS1 (Page 52)



Rhythm interlock
MW3 (Page 65)



VTile
CR2 (Page 59)



Large VTile
CR4 (Page 60)



Crescent V
CB2 (Page 65)

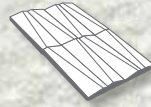

Dunes
DP1 (Page 66)



Paragon Chevron
PP1 (Page 67)

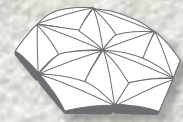

Paragon Hex
pp2 (Page 67)

SANDSTONE OCEAN SO

Tile surface: Honed

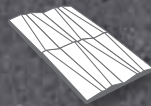

Dunes
DP1 (Page 66)



Paragon Chevron
PP1 (Page 67)

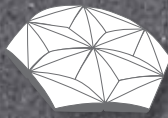

paragon Hex
PP2 (Page 67)

SANDSTONE GREY SG

Tile surface: Split Face

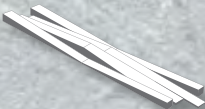

Rustic
CR1 (Page 57)

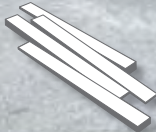

Rustic II
CR5 (Page 57)



Rhythm interlock
MW3 (Page 65)



Briq
CQ3 (Page 53)



Large VTile
CR4 (Page 60)



VTile
CR2 (Page 59)



Briq
CQ3 (Page 53)

GOLDEN SLATE GD

Tile surface: Split Face



Rustic
CR1 (Page 57)



Parallels
CL2 (Page 54)



Parallels V
CL3 (Page 55)



Cross Strip
CX1 (Page 56)



Strip
CS1 (Page 52)



VTile
CR2 (Page 59)



Large VTile
CR4 (Page 60)

SILVER QUARTZITIC SLATE SOLID SQUARE QS

Tile surface: Split Face & Honed

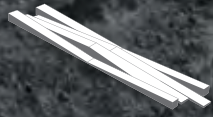

Rustic
CR1 (Page 57)

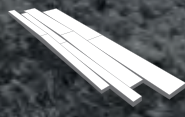

Parallels V
CL3 (Page 55)



Parallels
CL2 (Page 54)



Strip
CS1 (Page 52)



VTile
CR2 (Page 59)



Crescent VTile
cb2 (Page 65)

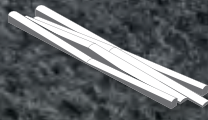

Crescent
Interlock
CB1 (Page 64)

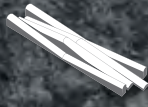

Crescent
Interlock Mini
CB3 (Page 64)

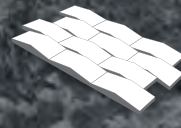

New Wave
MW2 (Page 66)

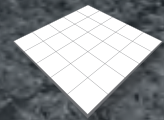

Classic Square
M48 (Page 70)

COPPER QUARTZITIC SLATE QC

Tile surface: Split Face & Honed

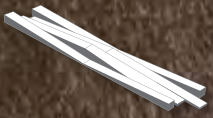

Rustic
CR1 (Page 57)



VTile
CR2 (Page 59)



Large VTile
CR4 (Page 60)



Slat
CT2 (Page 58)

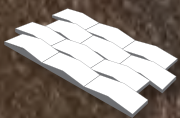

New Wave
MW2 (Page 66)

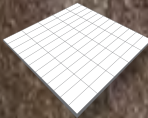

Avant
M22 (Page 71)

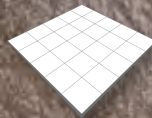

Classic Square
M48 (Page 70)

SOLID STONE TILE



Large VTile
CR4 (Page 60)

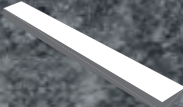

Slat
CT2 (Page 58)

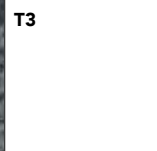

12"

12"

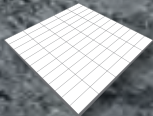

Avant
M22 (Page 71)



Cross Strips
CX1 (Page 56)

SUTRA BLACK

BM

Tile surface: Split Face & Honed

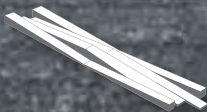

Rustic
CR1 (Page 57)



Rhythm interlock
MW3 (Page 65)

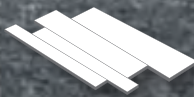

Parallels
CL2 (Page 54)

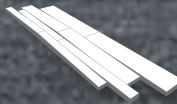

Parallels V
CL3 (Page 55)



VTile
CR2 (Page 59)



Large VTile
CR4 (Page 60)

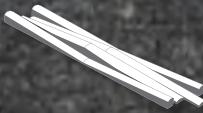

Crescent Interlock
CB1 (Page 64)

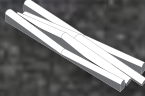

Crescent Interlock Mini
CB3 (Page 64)



Crescent VTile
CB2 (Page 65)

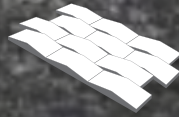

New Wave
MW2 (Page 66)

HIMACHAL BLACK HB

Tile surface: Split Face



Strip
CS1 (Page 52)

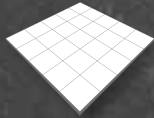

Classic Square
M48 (Page 70)

SOLID STONE TILE

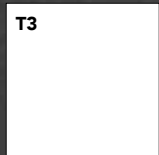

12"

12"

HIMACHAL WHITE HW

Tile surface: Split Face



Parallels
CL2 (Page 54)



Cross Strips
CX1 (Page 56)



Strip
CS1 (Page 52)

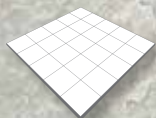

Classic Square
M48 (Page 70)

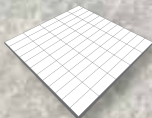

Avant (Split Face)
M22 (Page 71)

SOLID STONE TILE

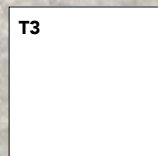

12"

12"







island
timber

4 ISLAND TIMBER



TIMBER CLADDING

ISLAND STONE'S ROOTS IN EXOTIC INDONESIA
ALLOWED US TO FALL IN LOVE WITH THE
RUGGED BEAUTY OF OLD GROWTH TEAK WOOD.

For centuries, the people of Central Java and Sumatra constructed homes using teak in the traditional "Joglo" design. The wood is as durable today as it was when first felled, making it a perfect option for recycled timber cladding.

We source teak locally from unused homes and buildings, and then restore the timber to its original luster and beauty while

preserving its storied history. Some of our timber displays natural teak colors ranging from light golden hues to weathered, smoky greys; some Island Timber captures the classic, bright painted colors of island homes.

Recycled teak allows your space to tell the story of the islands, and invites you to breathe new life into an ancient material.





PAPAN PLANKS

KP1

Coverage: 10.7 sq.ft/bundle.

Width: 6" (nominal
dimensions) wide panels of
varying length

Lengths & quantities of
panels/bundle:

39 1/2" (3 Panels),
31 1/2" (2 Panels)
23 1/2" (2 Panels),
15 3/4" (2 Panels)

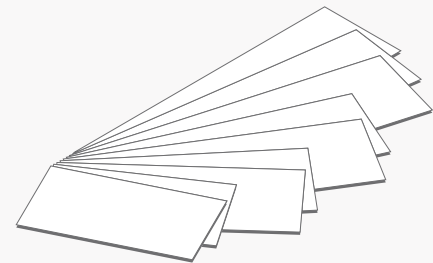

Natural
PLS



Painted
WRN

* A natural & painted mix is achieved by purchasing desired bundles of each and mixing them during installation.



RIMBA

KL3

15 3/4" x 7 1/8"
Lengths: 15 3/4"
Widths: 3 9/16", 2 3/8",
1 3/16"
Thickness: (Varied) 1/4- 3/8"

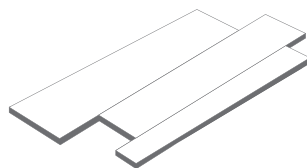

Tile surface:
Natural and/or painted
Interlocking tile

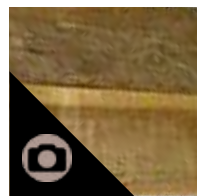

Natural
PLS

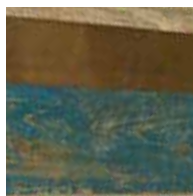

Mixed Natural
& Painted
WRN

KAYU V-WOOD

KR5

Tile size: 4 3/4" x 15 1/2"
(3/8" to 7/8" thick wedge).
Individual pieces: 1 1/8" x
15 1/2" (3/8" to 7/8" thick
wedge).

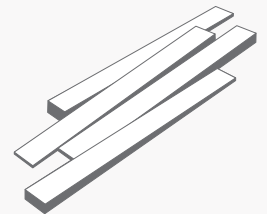

Tile surface:
Natural and/or painted
Interlocking tile

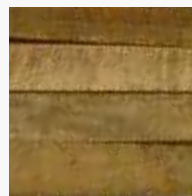

Natural
PLS

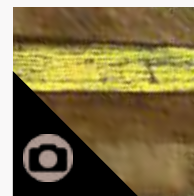

Mixed Natural
& Painted
WRN

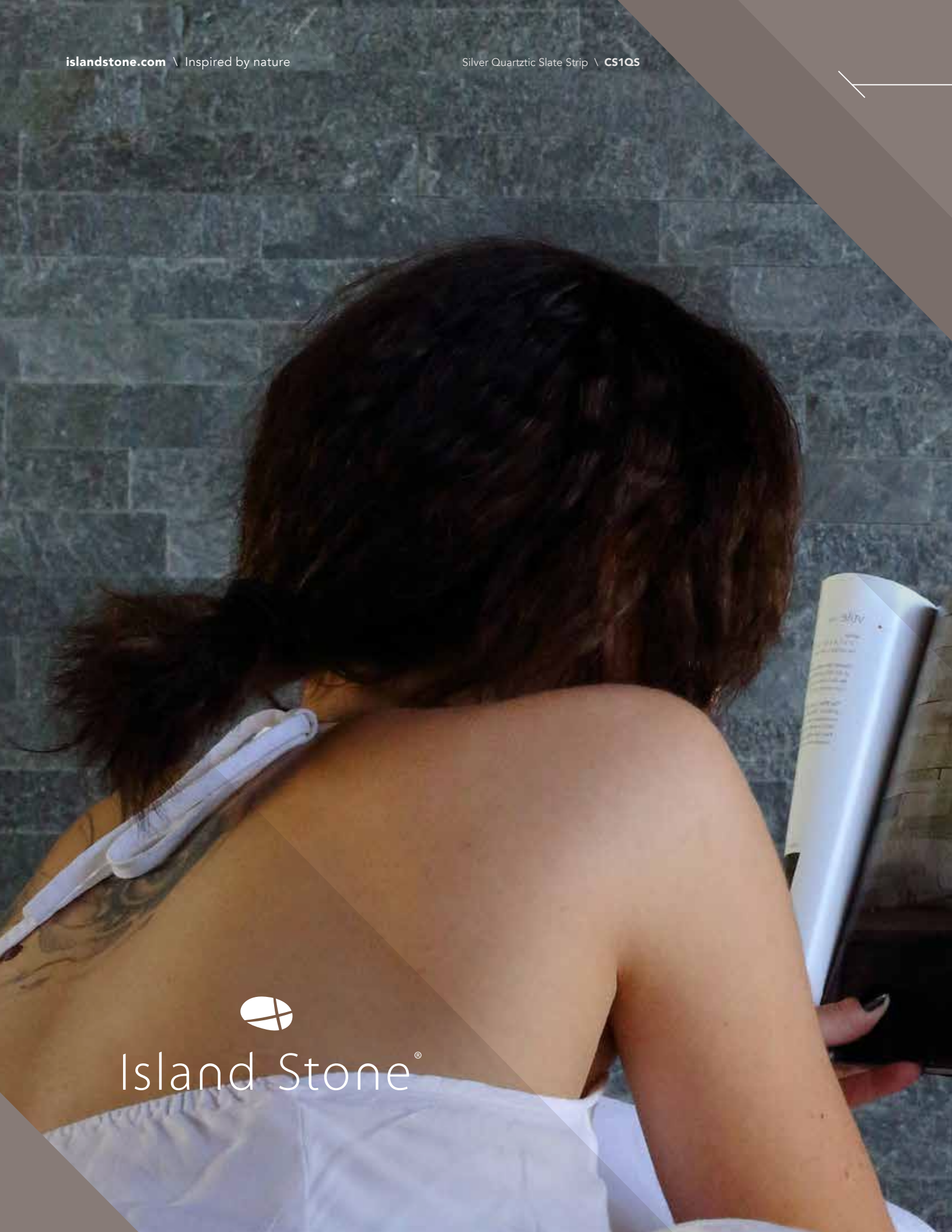

Island Stone®

5

INSTALLATION
INFORMATION



INFORMATION

PEBBLE & RANDOM

SEE THE DIFFERENCE

Island Stone cut pebble



Other un-cut pebble

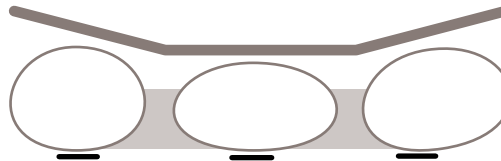

PEBBLE TEST RESULTS

| Material Code | pa | pc | pf | pg | pm/pw | pn | po | pr | ps | pv |
|--|---|-----------------------|--------------------|---------------------|----------------------------|--------------------|-----------------------|-----------------------|-----------------------|-----------------------|
| Material Name | Black and Tan Pebble | Medan Charcoal Pebble | French Tan Pebble | Flores Green Pebble | Antique Timor White Pebble | Native Earth Blend | Nightcap Blend | Java Grey Pebble | Sumba Speckled Pebble | Bird's Egg Blend |
| Description | Blend: pc & pf | Single Pebble | Single Pebble | Single Pebble | Single Pebble | Blend: pf & pr | Blend: pz & pc | Multiple Pebble Mix | Single Pebble | Blend: ps, pm & pg |
| Pebble/ Hue Variation | High | Low | Medium | Medium | Medium | High | Low | High | Low | High |
| Exterior Application | Yes | Yes | Yes | Yes | Yes | Yes | Yes | Yes | Yes | Yes |
| Floor Use (flat and natural surface finishes) | Yes | Yes | Yes | Yes | Yes | Yes | Yes | Yes | Yes | Yes |
| Water Application | Okay* | Okay* | Okay* | Okay* | Okay* | Okay* | Okay* | Okay* | Okay* | Okay* |
| Pool Application | No* | Okay* | No* | No* | Okay* | No* | Unknown | Okay* | Okay* | No* |
| Recommended Sealer | Recommended: Water based low sheen matte finish penetrating stone sealer. Oil based sealers tend to enhance/change color and create glossier finish. All sealers have an effect on color and should be tested on a sample swatch before final application | | | | | | | | | |
| Recommended Grout Color/Type | Sanded / Natural Grey | Sanded / Natural Grey | Sanded / Light Tan | Sanded / Light Tan | Sanded / Antique White | Sanded / Light Tan | Sanded / Natural Grey | Sanded / Natural Grey | Sanded / Natural Grey | Sanded / Natural Grey |

| Material Code | py | pz | cb | cg | ct | cw | | | | |
|--|---|-----------------------|----------------------------|---------------------------|----------------------------|-----------------------------|--|--|--|--|
| Material Name | Poppy Seed Blend | Alpine Pebble | Medan Charcoal/ French Tan | Flores Green/ Timor White | French Tan/ Medan Charcoal | Timor White /Medan Charcoal | | | | |
| Description | Blend: pm, pc & pf | Single Pebble | Blend pc & pf | Blend pg & pm | Blend pf & pcx | Blend pm & pc | | | | |
| Pebble/ Hue Variation | High | Low | High | High | High | High | | | | |
| Exterior Application | Yes | Yes | Yes | Yes | Yes | Yes | | | | |
| Floor Use (flat and natural surface finishes) | Yes | Yes | Yes | Yes | Yes | Yes | | | | |
| Water Application | Okay* | Okay* | Okay* | Okay* | Okay* | Okay* | | | | |
| Pool Application | No* | Unknown | No* | No* | No* | Okay* | | | | |
| Recommended Sealer | Recommended: Water based low sheen matte finish penetrating stone sealer. Oil based sealers tend to enhance/change color and create glossier finish. All sealers have an effect on color and should be tested on a sample swatch before final application | | | | | | | | | |
| Recommended Grout Color/Type | Sanded / Antique White | Sanded / Natural Grey | Sanded / Natural Grey | Sanded / Light Tan | Sanded / Light Tan | Sanded / Antique White | | | | |

*Okay: Utilizing natural stone in any harsher environment requires following appropriate guidelines as relates to installation and regular maintenance. Always use a qualified installer.
 *No : Not Recommended

FREQUENTLY ASKED QUESTIONS

- Q** Is installing these products difficult to do?
A Product is easy to install. Comprehensive Installation guidelines available online at www.islandstone.com.
- Q** How do you cut Pebble & Random mosaics?
A Use a standard wet tile saw with diamond blade for cutting stone.
- Q** Can product be used on corners and curved surfaces?
A Product is on mesh allowing it be applied to curved surfaces. Tiles are easily cut or hand placed to wrap edges.
- Q** Is product difficult to clean and maintain?
A Product is easy to maintain by regular sealing and can be cleaned with standard household cleaner appropriate for stone.
- Q** How do you clean these products?
A Any basic cleaner is appropriate for these stones. For heavier duty we recommend a cleaner designated for cleaning "Natural Stone".
- Q** Do these product require special maintenance?
A Natural stone maintenance is dependent on the environment. Resealing should occur periodically depending on the environment of the installation. Please refer to sealers for recommendations on when to reseal.
- Q** What is the recommended overage for a project.
A Generally we recommend ordering an additional 10%. For complicated projects involving extensive cutting (many edges) 15% should be considered.

RANDOM TILE TEST RESULTS

| Material Code | fx | ma | mb | mg | ml | mq | mw | mx | mz | qx |
|--|---|---------------------|----------------------|---------------------|----------------------|---------------------------|------------------------|------------------|---------------------|---------------------|
| Material Name | Forest Marble Mix | Grey Marble | Beige Marble | Tan & Grey Marble | Sterling Grey Marble | Beige Marble & Quartz Mix | Beige & Tan Marble Mix | Tan Marble | Black Basalt | Mixed Quartz |
| Description | Brown & Green | Single Stone | Stone & Glass | Blend: ma & mx | Single Stone | Blend: mb & qx | Blend: mb & mx | Single Stone | Single Stone | Quartz Blend |
| Hue Variation | High | low | low | low | low | high | low | low | low | High |
| Exterior Application | | Yes | Yes | Yes | Yes | Yes | Yes | Yes | Yes | Yes |
| Floor Use (flat and natural surface finishes) | Yes | Yes | Yes | Yes | Yes | Yes | Yes | Yes | Yes | Yes |
| Water Application | No* | Okay* | Okay* | Okay* | Okay* | Okay* | Okay* | Okay* | Okay* | Okay* |
| Pool Application | No* | Okay* | Okay* | Okay* | Okay* | Okay* | Okay* | Okay* | Okay* | Okay* |
| Recommended Sealer | Recommended: Water based low sheen matte finish penetrating stone sealer. Oil based sealers tend to enhance/change color and create glossier finish. For some stone it also brings out unique characteristics. All sealers have an effect on color and should be tested on a sample swatch before final application | | | | | | | | | |
| Recommended Grout Color/Type | Natural Grey/Sanded | Natural Grey/Sanded | Antique White/Sanded | Natural Grey/Sanded | Antique White/Sanded | Light Tan/Sanded | Light Tan/Sanded | Light Tan/Sanded | Natural Grey/Sanded | Bright White/Sanded |

| Material Code | rw | rz | xd | xf | xl | xx |
|--|---|------------------|--------------------|--------------------|----------------------|-------------------------|
| Material Name | White Marble | White Onyx | Black Forest Mix | French Mix | Sterling MegaMix | MegaMix Quartz & Marble |
| Description | Single Stone | Single Stone | Blend: fg, mz & ma | Blend: ma, mb & mx | Blend: ml, mb & mx | Blend: mc, mb, mx & qx |
| Pebble/ Hue Variation | Medium | High | Medium | Medium | Medium | High |
| Exterior Application | Yes | Yes | Yes | Yes | Yes | Yes |
| Floor Use (flat and natural surface finishes) | Yes | Yes | Yes | Yes | Yes | Yes |
| Water Application | Okay* | Okay* | No* | Okay* | Okay* | Okay* |
| Pool Application | Okay* | Okay* | No* | Okay* | Okay* | Okay* |
| Recommended Sealer | Recommended: Water based low sheen matte finish penetrating stone sealer. Oil based sealers tend to enhance/change color and create glossier finish. For some stone it also brings out unique characteristics. All sealers have an effect on color and should be tested on a sample swatch before final application | | | | | |
| Recommended Grout Color/Type | Bright White/Sanded | Light Tan/Sanded | Light Tan/Sanded | Light Tan/Sanded | Antique White/Sanded | Light Tan |

*Okay: Utilizing natural stone in any harsher environment requires following appropriate guidelines as relates to installation and regular maintenance. Always use a qualified installer.
 *No : Not Recommended

INFORMATION

GLASS

ISLAND STONE GLASS TILES AND MOSAICS ARE CREATED FROM A TRANSPARENT PANE OF GLASS THAT UNDERGOES A PROCESS IN WHICH A LAYER OF COLORED GLASS IS BAKED ONTO THE BACK SURFACE.

Behind the color a second layer of opaque (white) glass is baked to the back surface of the glass to maximize the brightness and allow for a through colored appearance.

FREQUENTLY ASKED QUESTIONS

- Q** Do I need a special contractor to install glass tile?
A Installing glass tile can be done by any qualified tile contractor. Installer should always follow TCNA guidelines to insure the quality of the final installation.
- Q** How do I cut Island Stone Glass?
A Island Stone glass should be cut with a wet saw equipped with a glass specific wet saw diamond blade to eliminate chipping of the tile when cutting. Scorers and snappers (not a saw) can be utilized for making simple cuts with linear designs. Cutting of non linear mosaics should always be done on a wet saw. Format specific techniques for cutting select glass mosaics are included in boxes as well as offered online under "resources at www.islandstone.com
- Q** What do I do if I chip the glass when cutting?
A Orders should always account for some overage, but for minor chips you can use a diamond sanding block.
- Q** What can I do if I crack a tile once installed?
A A qualified installer can cut out individual tiles using a dremel with a proper bit, but it requires careful handling to not damage other tiles.
- Q** What size grout joints do I use for glass?
A For Mosaics, joints between tiles should match spacing on meshed sheet. For Beach tiles we generally recommend 1/16" - 1/8" grout lines
- Q** Are there special requirements for installation cleanup?
A Special attention should be made when finishing a glass installation to insure no grout haze remains on surface- as once dry, grout can become more visible and affect finished installation.
- Q** How do I clean my glass tile?
A Any standard glass cleaner can be used for regular cleaning. For heavier duty cleaning we recommend using FILA PS87 which is a heavy duty tile specific cleaner.
- Q** Is the glass see through?
A The glass is transparent, but behind the color, we adhere an opaque white finish so that it can be applied over any surface without the color of the substrate affecting the brilliance of the tile.
- Q** Can I customize my order?
A Yes we offer custom service, including alternative colors, blends, textures, shapes, size, etc, but require minimum order quantities and lead times to produce.
- Q** What kind of grout should I use?
A While there are many possible options, we recommend using Bright White Sanded grout.
Recommended Products:
Grout: Bright White Sanded
Sealing: Not necessary for glass, we recommend using a specific grout sealer designed for glass tile.
Please ask your local tile dealer for available options
Recommended Glass Cleaner : FILA PS87
- Q** Can you use glass in areas that get hot?
A Yes glass will not be adversely affected by normal heated areas in a home.
- Q** Can you drill through glass?
A Yes, you can drill through glass, but should use a specialized bit designed to drill through porcelain and glass to avoid cracking glass during process.
- Q** What is the recommended overage for a project?
A Generally we recommend ordering an additional 10%. For complicated projects involving extensive cutting (many edge) 15% should be considered.
- Q** Beach Tile Specifications ?
A 665 lb Breaking Strength,
Freeze/Thaw: Passed,
COF: Dry .83 / Wet .72,
Resistance to Chemical Substance: Passed.

INFORMATION

QUARRIED STONE

THE STUNNING FORM OF ISLAND STONE'S QUARRIED STONE INTRODUCES A WHOLE NEW WORLD OF POSSIBILITIES.

Precision-cut, with either a natural or honed surface that enriches the color of the raw material, Island Stone Quarried Stone is truly transformational.

FREQUENTLY ASKED QUESTIONS

Q Can I grout claddings?

A Yes, generally designed as dry stack, flat surface (non wedge relief) claddings such as Strip can be grouted, but special care required related to cleaning grout during installation on split face finishes

Q Do I need to seal claddings?

A Depends on use. In exterior or wet environments claddings should always be sealed. Water based penetrating stone sealers are generally recommended, but in environments where stone will face extreme exposure, oil based waterproof penetrating stone sealers may offer better protection. Always test sealer on stone as sealers can dramatically change surface appearance.

Q Can natural stone products be used in wet areas?

A Yes, approved stones (see chart) can be used in wet environments but should be applied to a waterproofed surface and should be sealed appropriately.

Q Can claddings be used on floors?

A Yes, flat surface (non wedge relief) claddings can be used on floors.

Q What size grout joints do I use for solids?

A Grout joints can vary to fit the look one is trying to achieve, we generally recommend between 1/16"-1/4".

Q How do I turn corners with claddings?

A Both miter cuts and butt joints are options. For details visit our online resources section at www.islandstone.com

Q Are honed finished Solids tiles okay for floors?

A Solids can be used for floors. For COF specifications visit our online resources section at www.islandstone.com

Q Can materials be used on curved surfaces?

A Yes, materials can be applied to a curved surface. Direction and length of product used, define the minimum radius required for material to fit curve.

Q Can you install material on any surface?

A Material should only be applied to a solid, immobile surface. If applying to drywall, we recommend first covering wall with a solid concrete board. If applying to a unique surface material make sure adhesive used is designed to work with both the tile and surface.

Q What is the recommended overage for a project?

A Generally we recommend ordering an additional 10%. For complicated projects involving extensive cutting (many edge) 15% should be considered.

QUARRIED STONE TEST RESULTS

| Material Code | jc, jcc, jch | jg, jgc, jgh | jk | jo, joc, joh | jw, jwc, jwh | rw | wp | cp | tp | agc, agh, agx, akf &ax14s |
|--|-------------------|----------------------|--------------------|---------------------|----------------------|----------------------|-----------------------|-----------------------|-------------------|-------------------------------------|
| Material Name | Bali Creme Marble | Volcano Grey Marble | Budis Creme Marble | Exotic Sands Marble | Rice White Marble | White Marble | Tropical White | Island Sage | Tropical Tan | Grey and Flecked Andesite (chipped) |
| Description | Indonesian Marble | | | | | | Indonesian Limestone | | | Indonesian volcanic stone |
| Hue Variation | Low | Medium | Low | Medium | High | Medium | Low | Medium | Medium | Low |
| Exterior Application (Free Thaw approved) | *No | *No | *No | *No | *No | Okay* | Okay* | Okay* | Okay* | Okay* |
| Water Application/ Pool Application | Okay* | Okay* | Okay* | Okay* | Okay* | Okay* | *No | *No | *No | Okay* |
| Recommended Grout Color/Type | Sanded/ Light Tan | Sanded/ Natural Grey | Sanded/ Light Tan | Sanded/ Light Tan | Sanded/ Bright White | Sanded/ Bright White | Sanded/ Antique White | Sanded/ Antique White | Sanded/ Light Tan | Sanded/ Natural Grey |

| Material Code | bl | sm, smc | sg | so | hw, hw01s | hb | qc, qc13s | qs, qs09s | gd | bm & bm03s |
|--|---------------------------|-----------------------|----------------------|----------------------|----------------------|----------------------|-------------------|----------------------|-------------------|----------------------|
| Material Name | Temple Lava | Sandstone Mint | Sandstone Grey | Sandstone Ocean | Himachal White | Himachal Black | Copper Quartzite | Silver Quartzite | Golden Slate | Sutra Black |
| Description | Indonesian volcanic stone | Indian Sandstone | | | Indian Quartzite | | Indian Slate | | | |
| Hue Variation | Low | Low | Low | Low | High | Low | Low | Low | High | Low |
| Exterior Application (Free Thaw approved) | *No | Okay* | Okay* | Okay* | Okay* | Okay* | Okay* | Okay* | Okay* | Okay* |
| Water Application/ Pool Application | Okay* | *No | *No | *No | Okay* | Okay* | *No | Okay* | *No | Okay* |
| Recommended Grout Color/Type | Sanded/ Natural Grey | Sanded/ Antique White | Sanded/ Natural Grey | Sanded/ Natural Grey | Sanded/ Bright White | Sanded/ Natural Grey | Sanded/ Light Tan | Sanded/ Natural Grey | Sanded/ Light Tan | Sanded/ Natural Grey |

| Material Code | s10 | b10 |
|--|----------------------|------------------------|
| Material Name | Tan Square Blend | Grey Square Blend |
| Description | Blend: qc, mb, mx | Blend: qs, ag, hw & hb |
| Hue Variation | Low | Low |
| Exterior Application (Free Thaw approved) | Okay* | Okay* |
| Water Application/ Pool Application | *No | Okay* |
| Recommended Grout Color/Type | Sanded/ Natural Grey | Sanded/ Natural Grey |

*Okay: Utilizing natural stone in any harsher environment requires following appropriate guidelines as relates to installation and regular maintenance. Always use a qualified installer.
 *No : Not Recommended

VTILE

OPENING A NEW DIMENSION IN DESIGN

Arguably the most versatile natural stone material on the market, its unique 3-dimensional structure offers designers a myriad of approaches to creating dramatic contemporary designs. The points below outline what areas to consider when looking to create original distinctive VTile designs.

LAYING DIRECTION

Vertical

- Popular with smaller, taller surfaces, vertical VTile designs give surface a stronger, imposing presence.

Horizontal

- The most common approach, bringing a wall to life with a distinct eye-catching background.

Varying directions

- Creates a complex illusion of shapes as light plays over the crisscrossed wedges.

PROFILE - PLACEMENT



Wave

- Placing VTiles back to back to create an undulating surface with a natural personality.



Stack

- Placing VTiles in the same directional manner to create powerful geometric designs.

ELEVATION - OFFSETS

How an individual VTile is placed as relates to the piece placed prior.

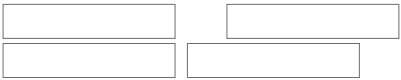

0% offset 25% offset



50% offset

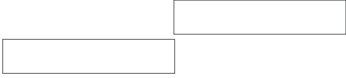

100% offset (wave design only)

VTILE SINGLE & MULTIFORMAT INSPIRATION

A small selection of the many popular, easy to install layouts for VTiles.



VTile - Stacked
25% offset



VTile - Wave
25% offset



VTile - Stacked
100% offset, opposing directions



VTile & Large V - 1 to 1 stacked
50% offset



VTile & Large V - 1 to 1 wave
50% offset



VTile & Large V - 2 to 1 stacked
50% offset, opposing directions

INFORMATION

ISLAND TIMBER

OUR WALL CLADDINGS ARE DESIGNED EXCLUSIVELY FOR WALLS AND/OR OTHER NON-TRAFFIC AREAS.

Panels and claddings are cut to a minimal thickness to offer a lightweight, versatile design. Surfaces are finished with a light coating to protect and enhance the product's appearance.

FREQUENTLY ASKED QUESTIONS

Q How do I install Island Timber products?

A Island Timber wood panels and claddings can be used on virtually any clean, flat and sealed surface. All timber products are designed to be permanently applied to a wall or ceiling. We recommend using an adhesive along with nails to adhere. Detailed instructions are available on our website.

Q Where can I use Island Timber?

A Island Timber wall claddings are designed exclusively for walls and/or other non traffic areas.

- Residential interior walls: Living room, bedroom room, kitchens and bathrooms.
- Commercial interior walls.
- Exterior. Teak is renown for its resilience to weather, but all wood will weather over time and tile installed in adverse or high exposure areas will require maintenance to keep product from deteriorating.
- Not recommended: High heat environments, wet environments, exposure to chemicals.

Q Who do I hire to install Island Timber?

A Tile installers or general contractors can install Island Timber products by following our instructions provided in detail on our website.

Q Can I use this in an area that has fire rating requirements?

A We have tested the ¼" thick teak and received back a "B" fire rating which is acceptable for most projects.

Q Where is the wood from?

A We salvage our reclaimed teak from homes in Indonesia that have previously been torn down.

Q Do I need to seal?

A No, sealing is not required. Teak contains natural oil that maintains its appearance. If used in an exterior installation, occasional re-application of teak oil is recommended.

Q Can I use for flooring?

A Use on floors is not recommended due to the thin design of the products.

Q Can material be used on a fireplace?

A Material can be used in areas of fireplace that are not exposed to flames such as facade.

Q Can wood be stained/painted after application?

A Product is sold as finished. Application of additional finishes is not recommended.

Q Can I get custom colors?

A Custom colors or single colors are available as a special order.

Q Does product need to acclimate before being applied?

A A one week acclimation period is recommended.

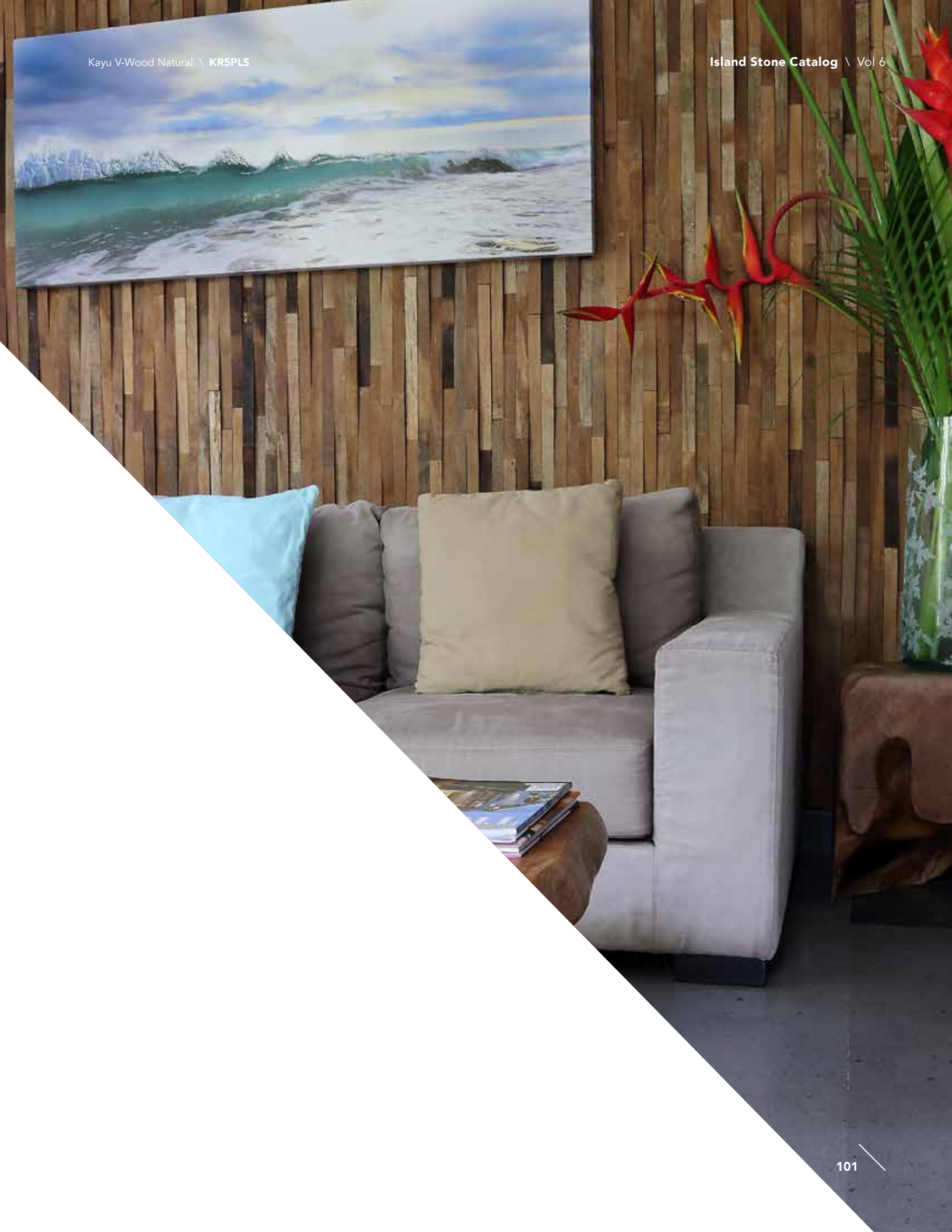



THANK YOU

ISLAND STONE'S PHILOSOPHY REVOLVES AROUND CONTINUALLY RE-INVENTING OURSELVES AND EMBRACING NEW MEDIUMS THAT BOTH COMPLIMENT AND ELEVATE OUR ORIGINAL ICONIC PEBBLE.

None of this innovation would be possible without the partnerships we have created around the world with creative, hard working, and compassionate people. Our exotic roots provide a continuous inspiration that moves us to share the rich beauty of Indonesia, our adopted island home.

Thank you for continuing to support Island Stone and Island Timber, and for believing in the pebble that would launch a 20-year business. We hope you enjoy the products made possible by inspired design, perseverance, and partnership.







Island Stone®

FOR FURTHER INFORMATION OR
YOUR NEAREST SUPPLIER PLEASE VISIT:
ISLANDSTONE.COM

Note: While every effort has been made to capture a true likeness to color,
color samples and photographs seen in this publication may not be an exact color match of product.
All images © Island Stone International Ltd, 2015. | © Island Stone International Ltd, 2015. All rights reserved.